

000000

Certified Boundary Survey

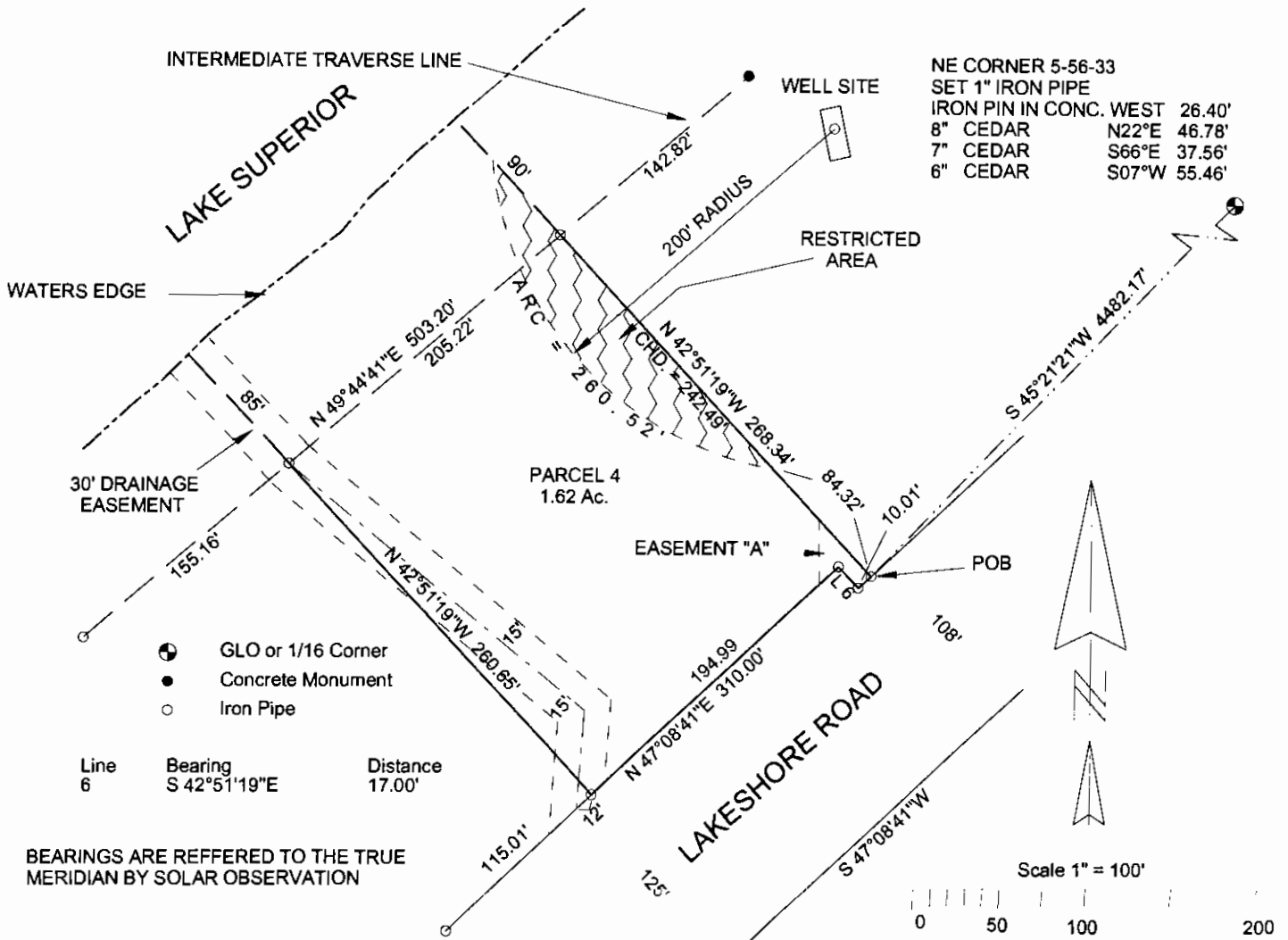

NE CORNER 5-56-33
 SET 1" IRON PIPE
 IRON PIN IN CONC. WEST 26.40'
 8" CEDAR N22°E 46.78'
 7" CEDAR S66°E 37.56'
 6" CEDAR S07°W 55.46'

BEARINGS ARE REFERRED TO THE TRUE MERIDIAN BY SOLAR OBSERVATION

LEGAL DESCRIPTION PARCEL 4

A parcel of land in Government Lot 3 of Section 5, T56N-R33W, Calumet Township, Houghton County, Michigan and described as follows:

Commencing at the NE Corner of Section 5, T56N-R33W, thence along the North line of said Section 5, S 89° 53' 54" W 138.76 feet to the Northerly boundary of Lakeshore Road; thence along the Northerly boundary of Lakeshore Road the following six courses, S 46° 03' 30" W 988.50 feet to a point of curve, concave to the left, having a radius of 1178.92 feet and a central angle of 13° 51' 50", and a chord of 284.57 feet bearing S 39° 07' 35" W; thence Southwesterly along said curve, a distance of 285.26 feet; thence S 32° 11' 40" W 412.30 feet to a point of curve, concave to the to the right, having a radius of 1112.92 feet, a central angle of 13° 42' 29", and a chord of 265.63 feet bearing S 39° 02' 56" W; thence Southwesterly along said curve, a distance of 266.27 feet; thence S 45° 54' 11" W 1472.05 feet; thence S 47° 08' 41" W 974.96 feet to the Point of Beginning; thence continuing Southwesterly along said line, a distance of 10.01 feet; thence N 42° 51' 19" W 17.00 feet; thence S 47° 08' 41" W 194.99 feet; thence N 42° 51' 19" W 260.65 feet to the shore of Lake Superior; thence along the shore of Lake Superior N 49° 44' 41" E 205.22 feet; thence S 42° 51' 19" E 268.34 feet to the Point of Beginning and containing 1.62 acres, more or less including all land to the ordinary high water mark of Lake Superior and also being Parcel 4 of a Plat of Survey of Calumet Lakeshore.

Subject to a 30 foot wide drainage easement, the centerline of which is the existing stream channel along the Southwesterly side of said Parcel 4 as shown on a Plat of Survey of Calumet Lakeshore.

SURVEYOR'S CERTIFICATE

TO: LAKE SUPERIOR LAND CO.

I James M. Pardini, a Professional Land Surveyor in the State of Michigan, hereby certify that I have surveyed the parcel of land described and delineated hereon, that said plat is a true representation of the survey as performed by me, and that said survey was performed with an error of closure of 1 IN 24,711 and that I have fully complied with the requirements of Public Act 132 of 1970.

James M. Pardini
 James M. Pardini, P.L.S. No. 32340

	JAMES M. PARDINI Professional Land Surveyor Calumet, Michigan 49913	
	1/19/2005 DATE	J. PARDINI DRAWN BY
SEC. 5, T56N-R33W		CALUMET TWP
FOR:		
SHEET 1 OF 1 SHEETS		

Certified Boundary Survey

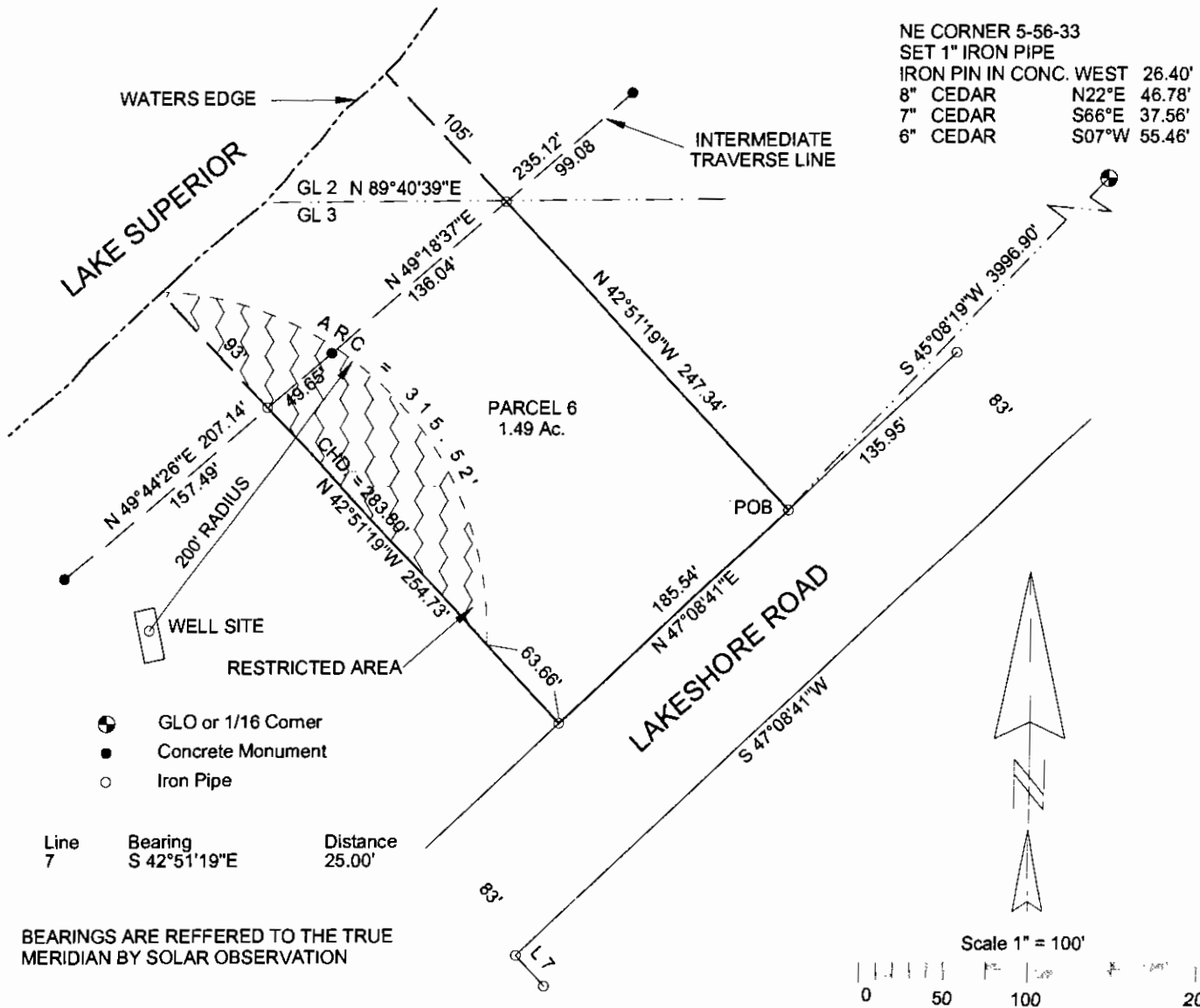

LEGAL DESCRIPTION PARCEL 6

A parcel of land in Government Lots 2 and 3 of Section 5, T56N-R33W, Calumet Township, Houghton County, Michigan and described as follows:

Commencing at the NE Corner of Section 5, T56N-R33W, thence along the North line of said Section 5, S 89° 53' 54" W 138.76 feet to the Northerly boundary of Lakeshore Road; thence along the Northerly boundary of Lakeshore Road the following six courses, S 46° 03' 30" W 988.50 feet to a point of curve, concave to the left, having a radius of 1178.92 feet and a central angle of 13° 51' 50", and a chord of 284.57 feet bearing S 39° 07' 35" W; thence Southwesterly along said curve, a distance of 285.26 feet; thence S 32° 11' 40" W 412.30 feet to a point of curve, concave to the to the right, having a radius of 1112.92 feet, a central angle of 13° 42' 29", and a chord of 265.63 feet bearing S 39° 02' 56" W; thence Southwesterly along said curve, a distance of 266.27 feet; thence S 45° 54' 11" W 1472.05 feet; thence S 47° 08' 41" W 489.42 feet to the Point of Beginning; thence continuing Southwesterly along said line, a distance of 185.54 feet; thence N 42° 51' 19" W 254.73 feet to the shore of Lake Superior; thence along the shore of Lake Superior N 49° 44' 26" E 49.65 feet; thence along the shore of Lake Superior N 49° 18' 37" E 136.04 feet; thence S 42° 51' 19" E 247.34 feet to the Point of Beginning and containing 1.49 acres, more or less, including all land to the ordinary high water mark of Lake Superior and also being Parcel 6 of a Plat of Survey of Calumet Lakeshore.

SURVEYOR'S CERTIFICATE

TO: LAKE SUPERIOR LAND CO.

I James M. Pardini, a Professional Land Surveyor in the State of Michigan, hereby certify that I have surveyed the parcel of land described and delineated hereon, that said plat is a true representation of the survey as performed by me, and that said survey was performed with an error of closure of 1 IN 24,711 and that I have fully complied with the requirements of Public Act 132 of 1970.

James M. Pardini
 James M. Pardini, P.L.S. No. 32340

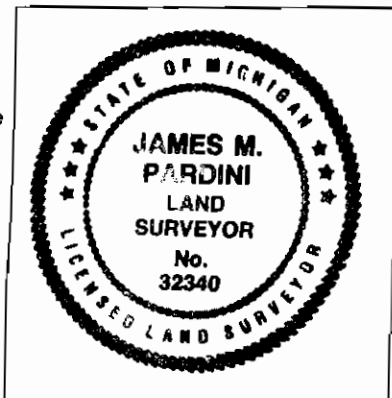

JAMES M. PARDINI Professional Land Surveyor Calumet, Michigan 49913		
1/19/2005 DATE	J. PARDINI DRAWN BY	1" = 100' SCALE
SEC. 5, T56N-R33W.		CALUMET TWP.
FOR:		
SHEET 1 OF 1 SHEETS		

Certified Boundary Survey

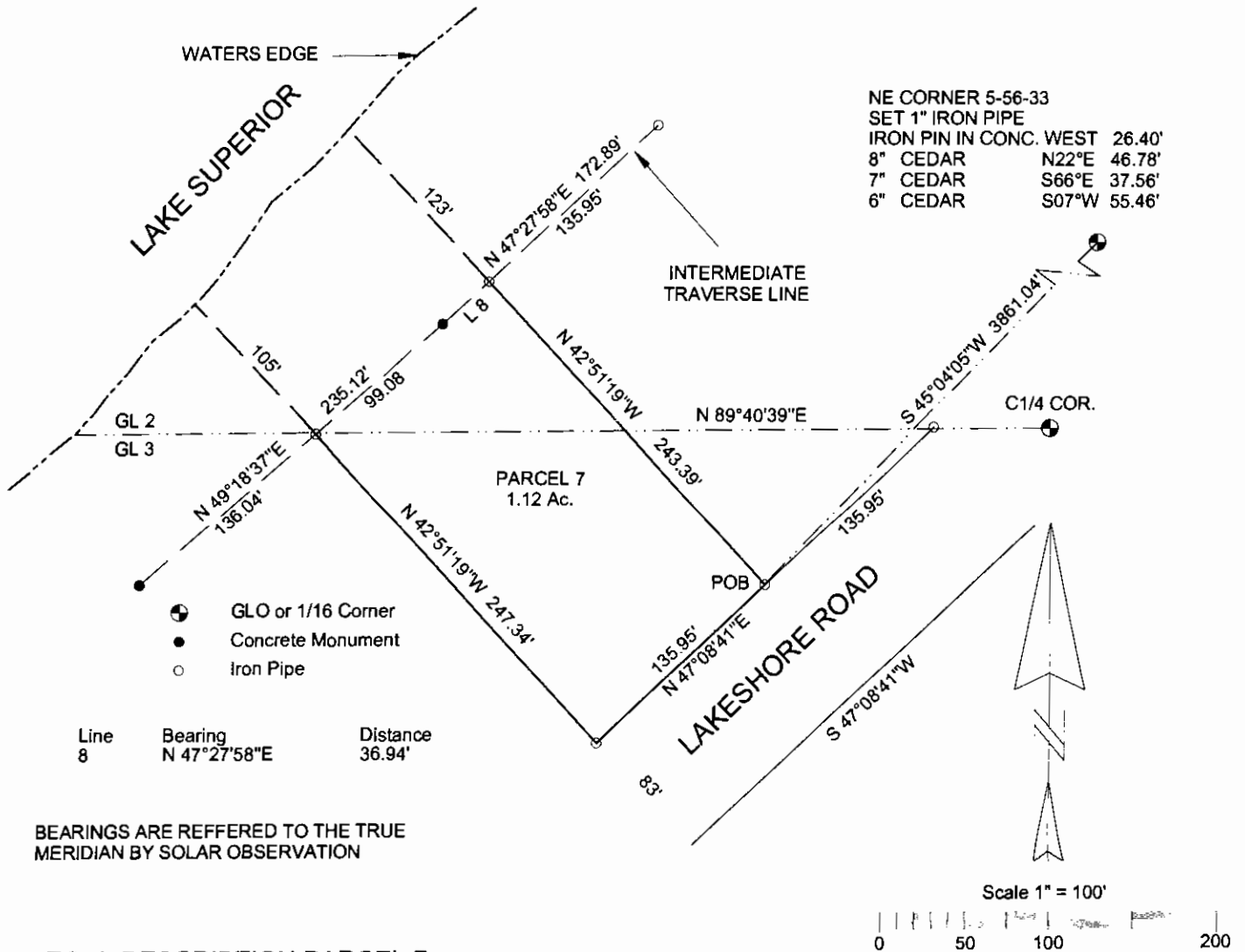

LEGAL DESCRIPTION PARCEL 7

A parcel of land in Government Lots 2 and 3 of Section 5, T56N-R33W, Calumet Township, Houghton County, Michigan and described as follows:

Commencing at the NE Corner of Section 5, T56N-R33W, thence along the North line of said Section 5, S 89° 53' 54" W 138.76 feet to the Northerly boundary of Lakeshore Road; thence along the Northerly boundary of Lakeshore Road the following six courses, S 46° 03' 30" W 988.50 feet to a point of curve, concave to the left, having a radius of 1178.92 feet and a central angle of 13° 51' 50", and a chord of 284.57 feet bearing S 39° 07' 35" W; thence Southwesterly along said curve, a distance of 285.26 feet; thence S 32° 11' 40" W 412.30 feet to a point of curve, concave to the to the right, having a radius of 1112.92 feet, a central angle of 13° 42' 29", and a chord of 265.63 feet bearing S 39° 02' 56" W; thence Southwesterly along said curve, a distance of 266.27 feet; thence S 45° 54' 11" W 1472.05 feet; thence S 47° 08' 41" W 353.47 feet to the Point of Beginning; thence continuing Southwesterly along said line, a distance of 135.95 feet; thence S 42° 51' 19" E 247.34 feet to the shore of Lake Superior; thence along the shore of Lake Superior N 49° 18' 37" E 99.08 feet; thence along the shore of Lake Superior N 47° 27' 58" E 36.94 feet; thence S 42° 51' 19" E 243.39 feet to the Point of Beginning and containing 1.12 acres, more or less, including all land to the ordinary high water mark of Lake Superior and also being Parcel 7 of a Plat of Survey of Calumet Lakeshore.

SURVEYOR'S CERTIFICATE

TO: LAKE SUPERIOR LAND CO.

I James M. Pardini, a Professional Land Surveyor in the State of Michigan, hereby certify that I have surveyed the parcel of land described and delineated hereon, that said plat is a true representation of the survey as performed by me, and that said survey was performed with an error of closure of 1 IN 24,711 and that I have fully complied with the requirements of Public Act 132 of 1970.

James M. Pardini
 James M. Pardini, P.L.S. No. 32340

			JAMES M. PARDINI Professional Land Surveyor Calumet, Michigan 49913		
			1/20/2005 DATE	J. PARDINI DRAWN BY	1" = 100' SCALE
SEC. 5, T56N-R33W			CALUMET TWP.		
FOR:					
SHEET 1 OF 1 SHEETS					

Certified Boundary Survey

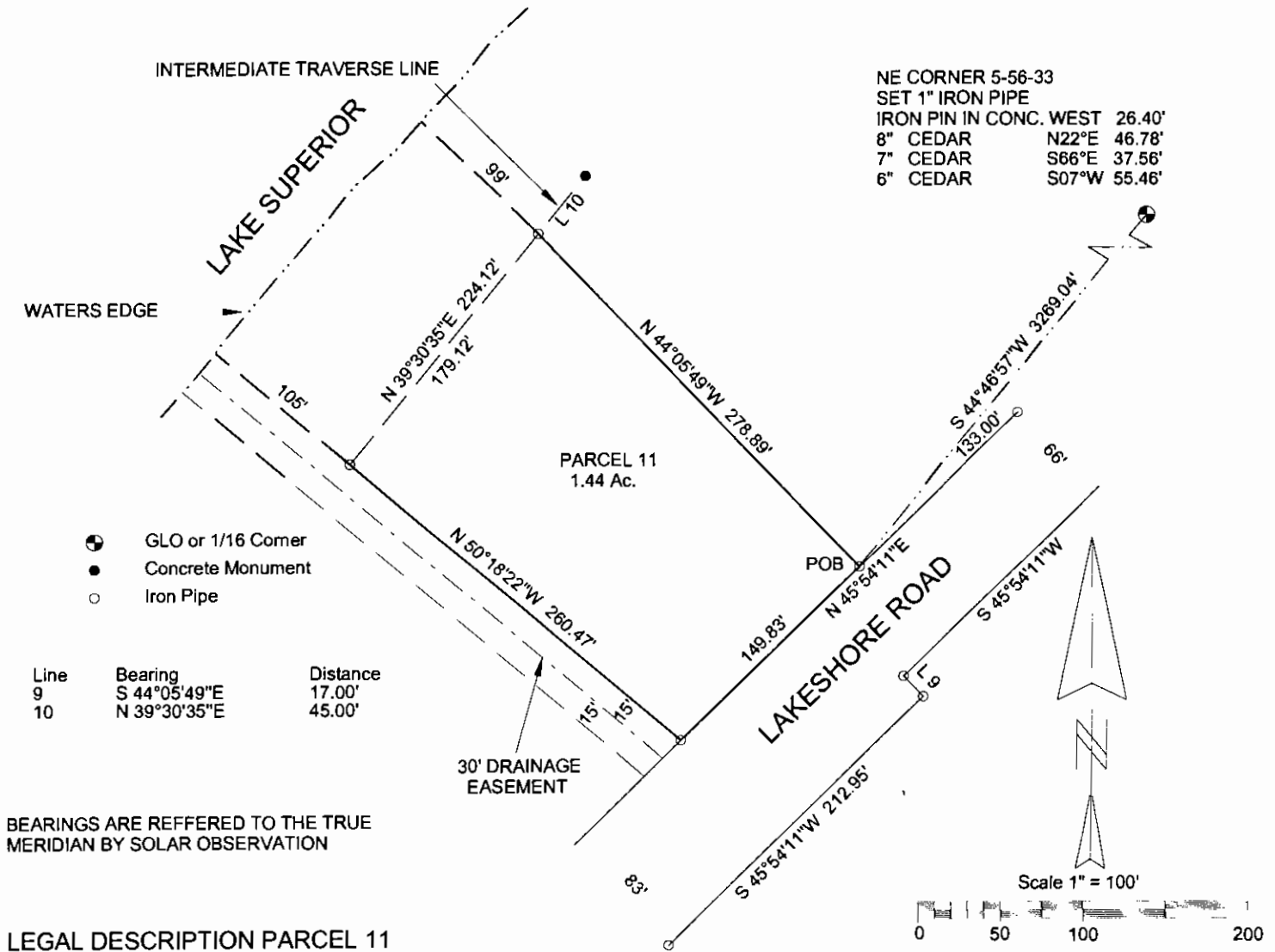

A parcel of land in Government Lot 2 of Section 5, T56N-R33W, Calumet Township, Houghton County, Michigan and described as follows:

Commencing at the NE Corner of Section 5, T56N-R33W, thence along the North line of said Section 5, S 89° 53' 54" W 138.76 feet to the Northerly boundary of Lakeshore Road; thence along the Northerly boundary of Lakeshore Road the following five courses, S 46° 03' 30" W 988.50 feet to a point of curve, concave to the left, having a radius of 1178.92 feet and a central angle of 13° 51' 50", and a chord of 284.57 feet bearing S 39° 07' 35" W; thence Southwesterly along said curve, a distance of 285.26 feet; thence S 32° 11' 40" W 412.30 feet to a point of curve, concave to the to the right, having a radius of 1112.92 feet, a central angle of 13° 42' 29", and a chord of 265.63 feet bearing S 39° 02' 56" W; thence Southwesterly along said curve, a distance of 266.27 feet; thence S 45° 54' 11" W 1233.22 feet to the Point of Beginning; thence continuing Southwesterly along said line, a distance of 149.83 feet; thence N 50° 18' 22" W 260.47 feet to the shore of Lake Superior; thence along the shore of Lake Superior N 39° 30' 35" E 179.12 feet; thence S 44° 05' 49" E 278.89 feet to the Point of Beginning and containing 1.44 acres, more or less, including all land to the ordinary high water mark of Lake Superior and also being Parcel 11 of a Plat of Survey of Calumet Lakeshore.

Subject to a 30 foot wide drainage easement, the centerline of which is the existing stream channel along the Southwesterly side of said Parcel 11 as shown on a Plat of Survey of Calumet Lakeshore.

SURVEYOR'S CERTIFICATE

TO: LAKE SUPERIOR LAND CO.

I James M. Pardini, a Professional Land Surveyor in the State of Michigan, hereby certify that I have surveyed the parcel of land described and delineated hereon, that said plat is a true representation of the survey as performed by me, and that said survey was performed with an error of closure of 1 IN 24,711 and that I have fully complied with the requirements of Public Act 132 of 1970.

James M. Pardini
 James M. Pardini, P.L.S. No. 32340

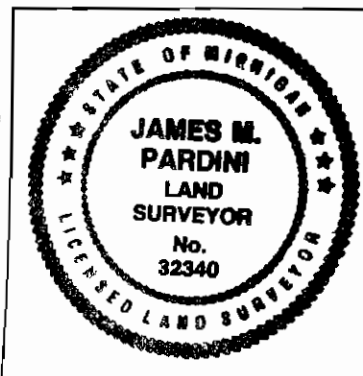

JAMES M. PARDINI Professional Land Surveyor Calumet, Michigan 49913		
1/20/2002	J. PARDINI	1" = 100'
DATE	DRAWN BY	SCALE
SEC. 5, T56N-R33W		CALUMET TWP.
FOR:		
SHEET 1 OF 1 SHEETS		

Certified Boundary Survey

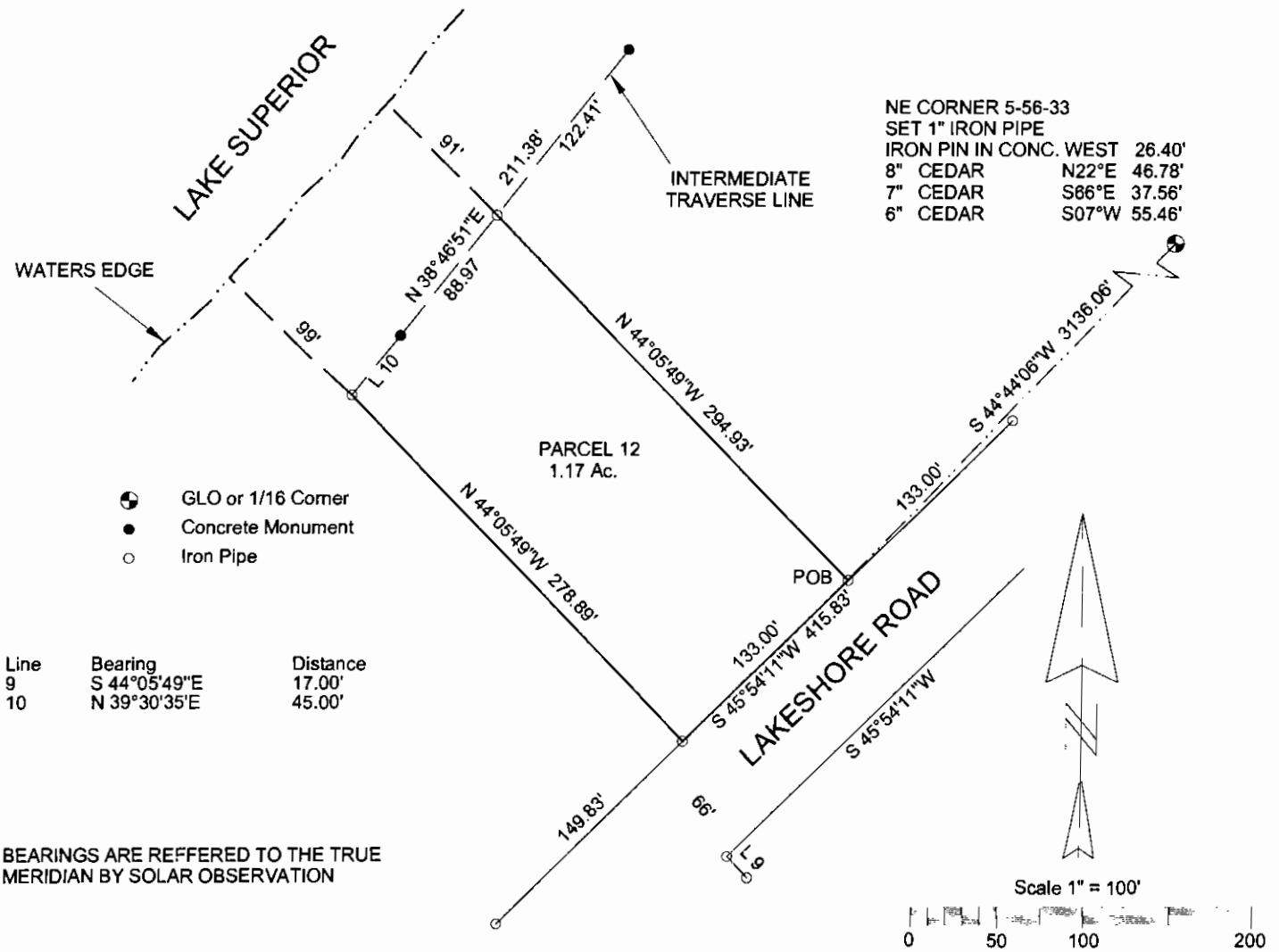

LEGAL DESCRIPTION PARCEL 12

A parcel of land in Government Lot 2 of Section 5, T56N-R33W, Calumet Township, Houghton County, Michigan and described as follows:

Commencing at the NE Corner of Section 5, T56N-R33W, thence along the North line of said Section 5, S 89° 53' 54" W 138.76 feet to the Northerly boundary of Lakeshore Road; thence along the Northerly boundary of Lakeshore Road the following five courses, S 46° 03' 30" W 988.50 feet to a point of curve, concave to the left, having a radius of 1178.92 feet and a central angle of 13° 51' 50", and a chord of 284.57 feet bearing S 39° 07' 35" W; thence Southwesterly along said curve, a distance of 285.26 feet; thence S 32° 11' 40" W 412.30 feet to a point of curve, concave to the to the right, having a radius of 1112.92 feet, a central angle of 13° 42' 29", and a chord of 265.63 feet bearing S 39° 02' 56" W; thence Southwesterly along said curve, a distance of 266.27 feet; thence S 45° 54' 11" W 1100.22 feet to the Point of Beginning; thence continuing Southwesterly along said line, a distance of 133.00 feet; thence N 44° 05' 49" W 278.89 feet to the shore of Lake Superior; thence along the shore of Lake Superior N 39° 30' 35" E 45.00 feet; thence along the shore of Lake Superior N 38° 46' 51" E 88.97 feet; thence S 44° 05' 49" E 294.93 feet to the Point of Beginning and containing 1.17 acre, more or less, including all land to the ordinary high water mark of Lake Superior and also being Parcel 12 of a Plat of Survey of Calumet Lakeshore.

SURVEYOR'S CERTIFICATE

TO: LAKE SUPERIOR LAND CO.

I James M. Pardini, a Professional Land Surveyor in the State of Michigan, hereby certify that I have surveyed the parcel of land described and delineated hereon, that said plat is a true representation of the survey as performed by me, and that said survey was performed with an error of closure of 1 IN 24,711 and that I have fully complied with the requirements of Public Act 132 of 1970.

James M. Pardini
 James M. Pardini, P.L.S. No. 32340

	JAMES M. PARDINI Professional Land Surveyor Calumet, Michigan 49913		
	1/20/2005 DATE	J. PARDINI DRAWN BY	1" = 100' SCALE
SEC. 5, T56N-R33W CALUMET TWP.			
FOR:			
SHEET 1 OF 1 SHEETS			

000735

Mary Schoos

1P

Register of Deeds

PAU Date 02/14/2005 Time 11:09:40

FEE: 14.00

Page 1 of 1

SM 3/735

Certified Boundary Survey

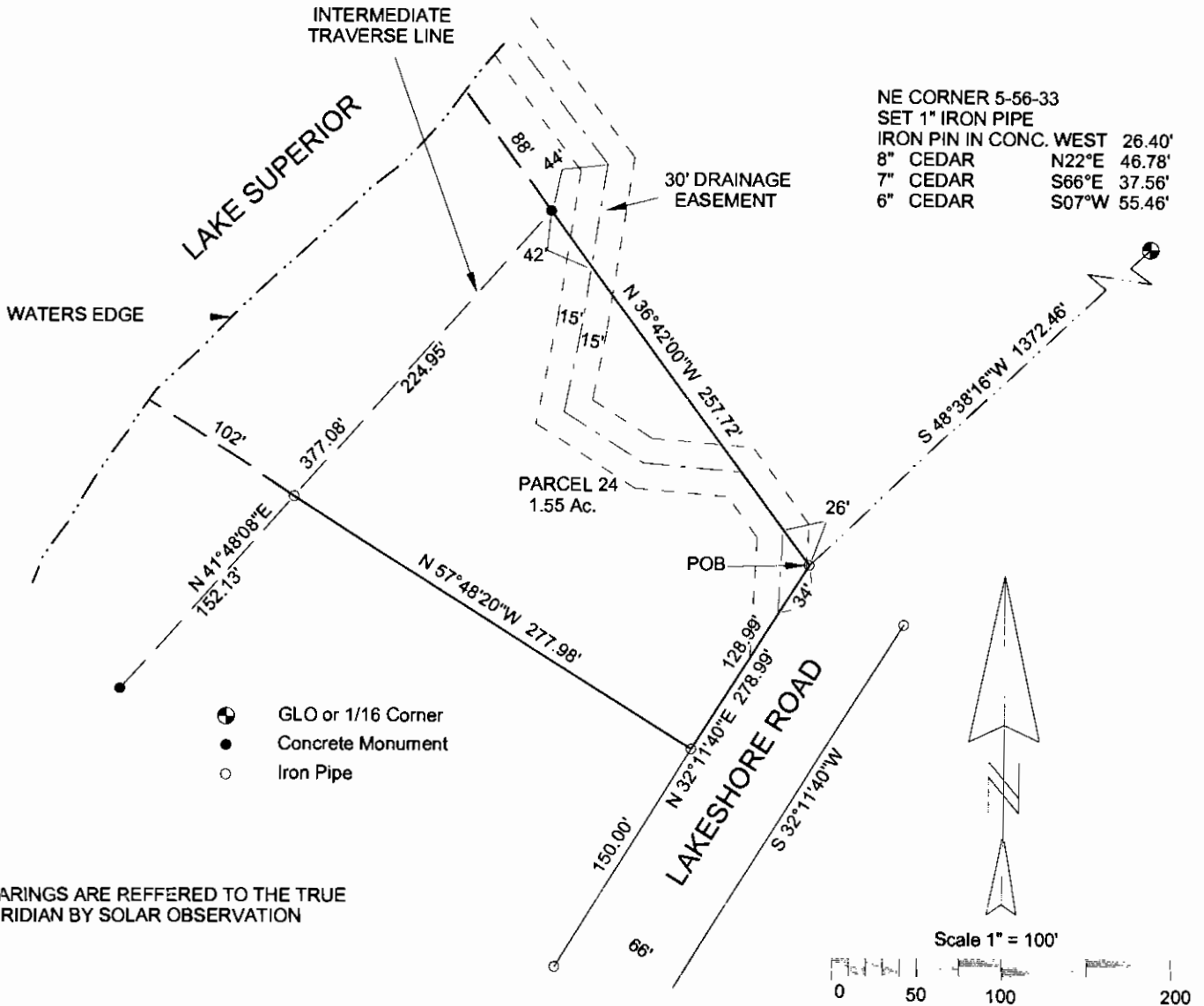

LEGAL DESCRIPTION PARCEL 24

A parcel of land in Government Lot 1 of Section 5, T56N-R33W, Calumet Township, Houghton County, Michigan and described as follows:

Commencing at the NE Corner of Section 5, T56N-R33W, thence along the North line of said Section 5, S 89° 53' 54" W 138.76 feet to the Northerly boundary of Lakeshore Road; thence along the Northerly boundary of Lakeshore Road the following two courses, S 46° 03' 30" W 988.50 feet to a point of curve, concave to the left, having a radius of 1178.92 feet and a central angle of 13° 51' 50", and a chord of 284.57 feet bearing S 39° 07' 35" W; thence Southwesterly along said curve, a distance of 285.26 feet to the end of the curve, said point being the Point of Beginning; thence S 32° 11' 40" W 128.99 feet; thence N 57° 48' 20" W 277.98 feet to the shore of Lake Superior; thence along the shore of Lake Superior N 41° 48' 08" E 224.95 feet; thence S 36° 42' 00" E 257.72 feet to the Point of Beginning and containing 1.55 acres, more or less, including all land to the ordinary high water mark of Lake Superior and also being Parcel 24 of a Plat of Survey of Calumet Lakeshore.

Subject to a 30 foot wide drainage easement, the centerline of which is the existing stream channel along the Northeasterly side of said Parcel 24 as shown on a Plat of Survey of Calumet Lakeshore.

SURVEYOR'S CERTIFICATE

TO: LAKE SUPERIOR LAND CO.

I James M. Pardini, a Professional Land Surveyor in the State of Michigan, hereby certify that I have surveyed the parcel of land described and delineated hereon, that said plat is a true representation of the survey as performed by me, and that said survey was performed with an error of closure of 1 IN 24,711 and that I have fully complied with the requirements of Public Act 132 of 1970.

James M. Pardini
James M. Pardini, P.L.S. No. 32340

			JAMES M. PARDINI Professional Land Surveyor Calumet, Michigan 49913		
			1/21/2005 DATE	J. PARDINI DRAWN BY	1" = 100' SCALE
SEC. 5, T56N-R33W			CALUMET TWP.		
FOR:					
SHEET 1 OF 1 SHEETS					

000736

Certified Boundary Survey

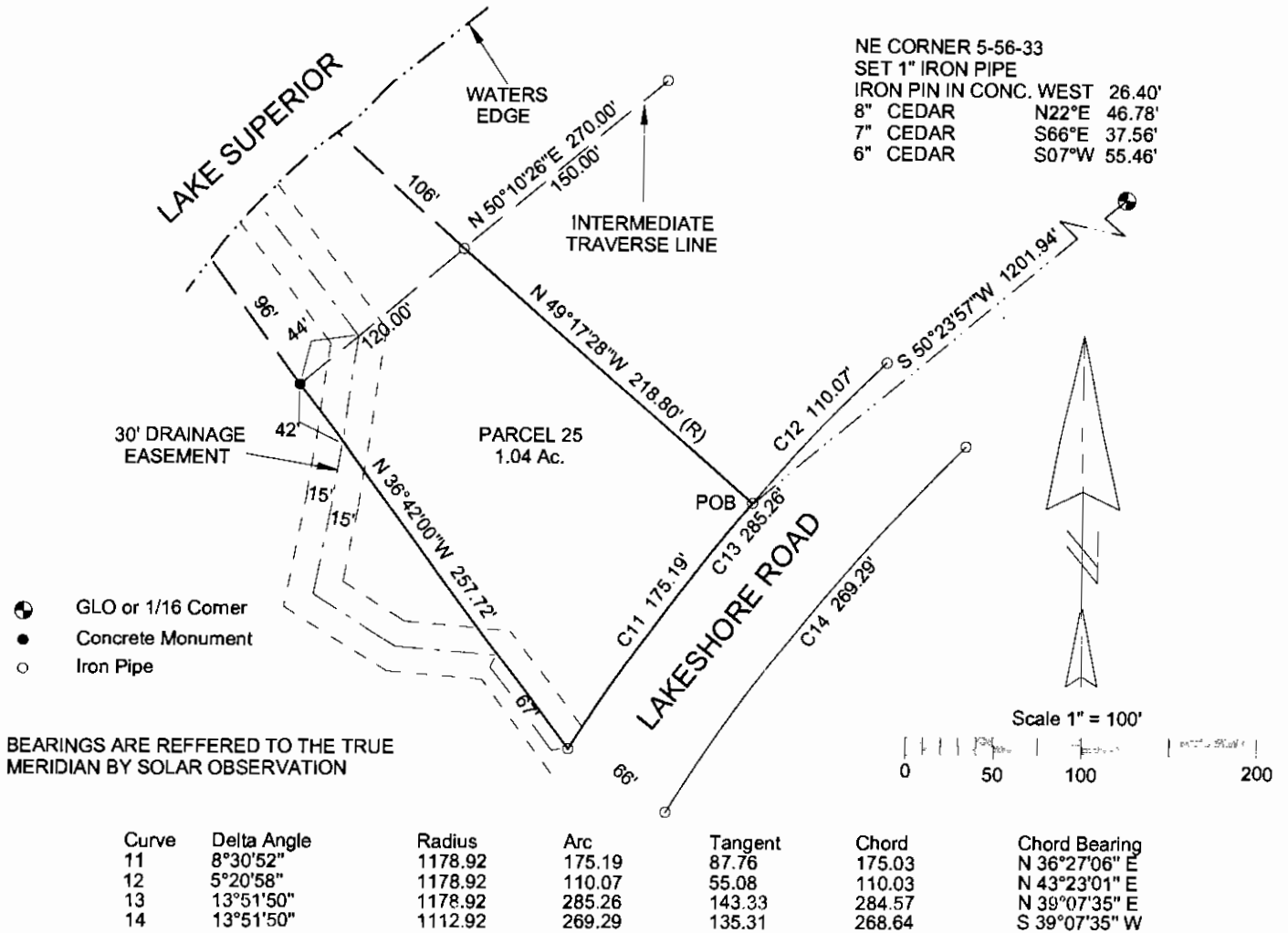

LEGAL DESCRIPTION PARCEL 25

A parcel of land in Government Lot 1 of Section 5, T56N-R33W, Calumet Township, Houghton County, Michigan and described as follows:

Commencing at the NE Corner of Section 5, T56N-R33W, thence along the North line of said Section 5, S 89° 53' 54" W 138.76 feet to the Northerly boundary of Lakeshore Road; thence along the Northerly boundary of Lakeshore Road the following two courses, S 46° 03' 30" W 988.50 feet to a point of curve, concave to the left, having a radius of 1178.92 feet and a central angle of 5° 20' 58", and a chord of 110.03 feet bearing S 43° 23' 01" W; thence Southwesterly along said curve, a distance of 110.07 feet to the Point of Beginning; thence continuing Southwesterly along said curve, 175.19 feet; thence N 36° 42' 00" W 257.72 feet to the shore of Lake Superior; thence along the shore of Lake Superior N 50° 10' 26" E 120.00 feet; thence S 49° 17' 28" E 218.80 feet to the Point of Beginning and containing 1.04 acres, more or less, including all land to the ordinary high water mark of Lake Superior and also being Parcel 25 of a Plat of Survey of Calumet Lakeshore.

Subject to a 30 foot wide drainage easement, the centerline of which is the existing stream channel along the Southwesterly side of said Parcel 25 as shown on a Plat of survey of Calumet Lakeshore.

SURVEYOR'S CERTIFICATE

TO: LAKE SUPERIOR LAND CO.

I James M. Pardini, a Professional Land Surveyor in the State of Michigan, hereby certify that I have surveyed the parcel of land described and delineated hereon, that said plat is a true representation of the survey as performed by me, and that said survey was performed with an error of closure of 1 IN 24,711 and that I have fully complied with the requirements of Public Act 132 of 1970.

James M. Pardini
 James M. Pardini, P.L.S. No. 32340

			JAMES M. PARDINI Professional Land Surveyor Calumet, Michigan 49913		
			1/21/2005 DATE	J. PARDINI DRAWN BY	1" = 100' SCALE
SEC. 5, T56N-R33W			CALUMET TWP.		
FOR:					
SHEET 1 OF 1 SHEETS					

000737

Certified Boundary Survey

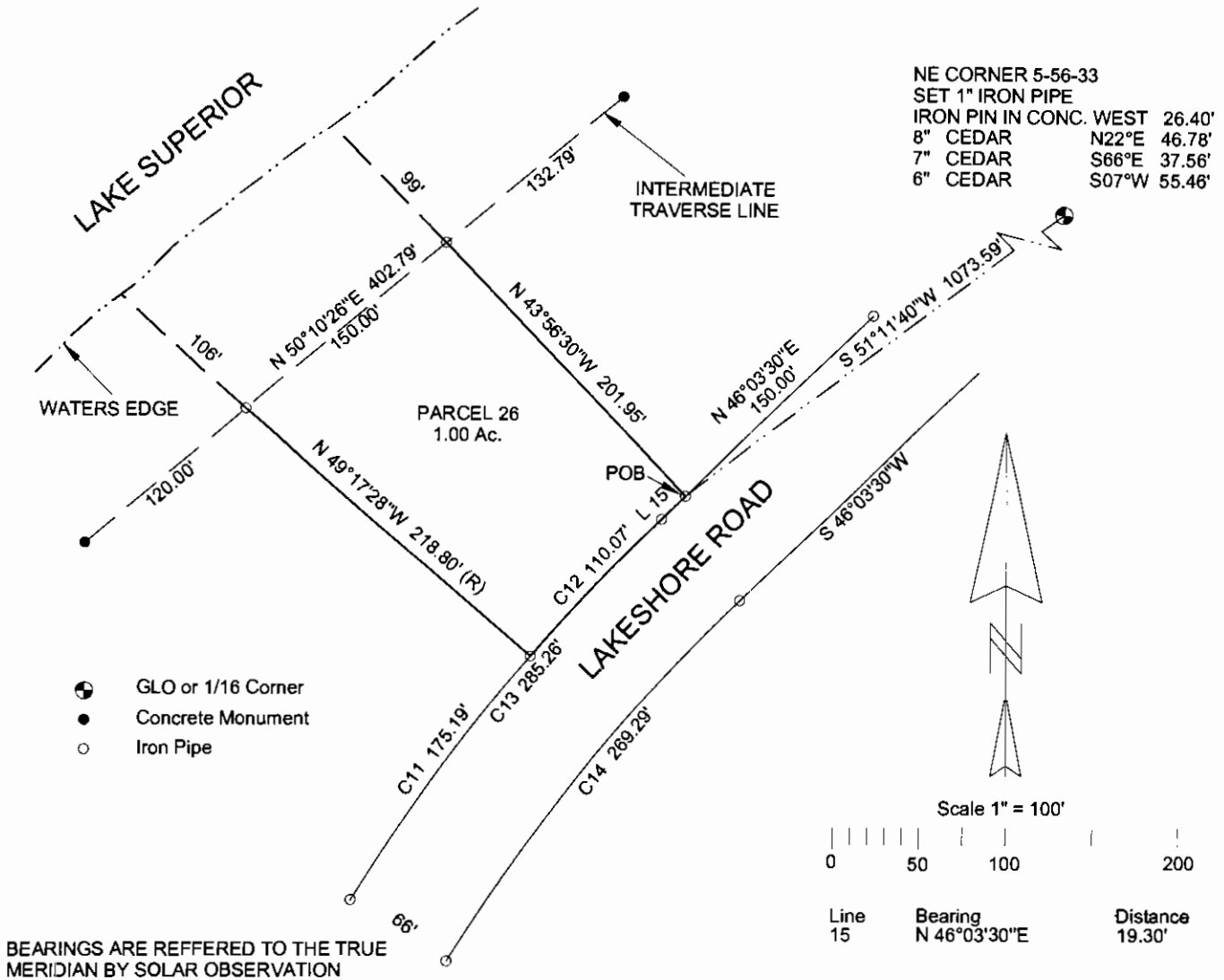

NE CORNER 5-56-33
 SET 1" IRON PIPE
 IRON PIN IN CONC. WEST 26.40'
 8" CEDAR N22°E 46.78'
 7" CEDAR S66°E 37.56'
 6" CEDAR S07°W 55.46'

BEARINGS ARE REFERRED TO THE TRUE MERIDIAN BY SOLAR OBSERVATION

Curve	Delta Angle	Radius	Arc	Tangent	Chord	Chord Bearing
11	8°30'52"	1178.92	175.19	87.76	175.03	N 36°27'06" E
12	5°20'58"	1178.92	110.07	55.08	110.03	N 43°23'01" E
13	13°51'50"	1178.92	285.26	143.33	284.57	N 39°07'35" E
14	13°51'50"	1112.92	269.29	135.31	268.64	S 39°07'35" W

LEGAL DESCRIPTION PARCEL 26

A parcel of land in Government Lot 1 of Section 5, T56N-R33W, Calumet Township, Houghton County, Michigan and described as follows:

Commencing at the NE Corner of Section 5, T56N-R33W, thence along the North line of said Section 5, S 89° 53' 54" W 138.76 feet to the Northerly boundary of Lakeshore Road; thence along the Northerly boundary of Lakeshore Road S 46° 03' 30" W 969.20 feet to the Point of Beginning; thence continuing Southwesterly along said line, a distance of 19.30 feet to a point of curve, concave to the left, having a radius of 1178.92 feet and a central angle of 5° 20' 58", and a chord of 110.03 feet bearing S 43° 23' 01" W; thence Southwesterly along said curve, a distance of 110.07 feet; thence N 49° 17' 28" W 218.80 feet to the shore of Lake Superior; thence along the shore of Lake Superior N 50° 10' 26" E 150.00 feet; thence S 43° 56' 30" E 201.95 feet to the Point of Beginning and containing 1.0 acre, more or less, including all land to the ordinary high water mark of Lake Superior and also being Parcel 26 of a Plat of Survey of Calumet Lakeshore.

SURVEYOR'S CERTIFICATE

TO: LAKE SUPERIOR LAND CO.

I, James M. Pardini, a Professional Land Surveyor in the State of Michigan, hereby certify that I have surveyed the parcel of land described and delineated hereon, that said plat is a true representation of the survey as performed by me, and that said survey was performed with an error of closure of 1 IN 24,711 and that I have fully complied with the requirements of Public Act 132 of 1970.

James M. Pardini
 James M. Pardini, P.L.S. No. 32340

			JAMES M. PARDINI Professional Land Surveyor Calumet, Michigan 49913		
			1/21/2005	J. PARDINI	1" = 100'
DATE	DRAWN BY	SCALE			
SEC. 5, T56N-R33W			CALUMET TWP.		
FOR:					
SHEET 1 OF 1 SHEETS					

000738

Certified Boundary Survey

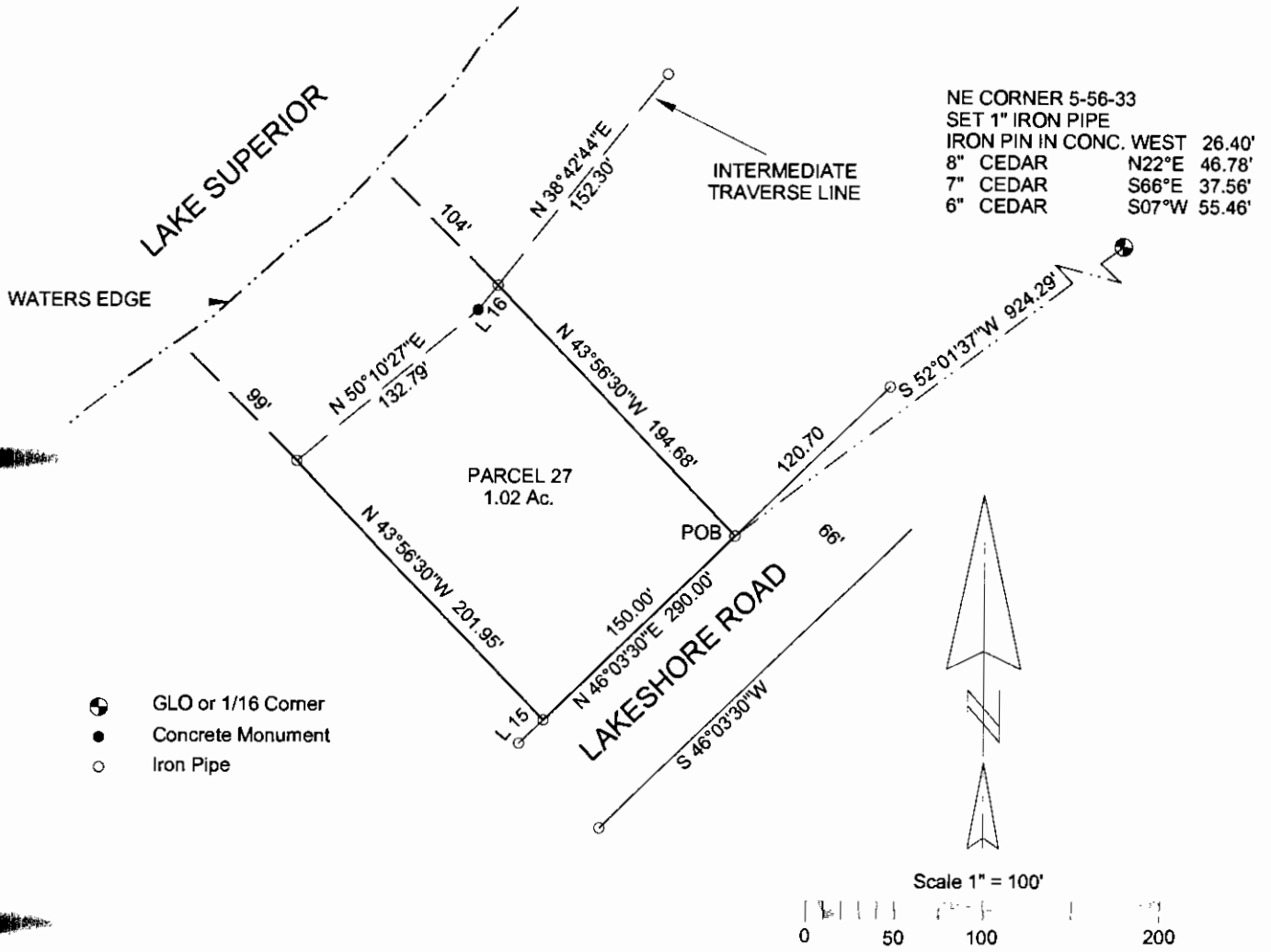

- ⊙ GLO or 1/16 Corner
- Concrete Monument
- Iron Pipe

BEARINGS ARE REFERRED TO THE TRUE MERIDIAN BY SOLAR OBSERVATION

Line	Bearing	Distance
15	N 46°03'30"E	19.30'
16	N 38°42'44"E	17.69'

LEGAL DESCRIPTION PARCEL 27

A parcel of land in Government Lot 1 of Section 5, T56N-R33W, Calumet Township, Houghton County, Michigan and described as follows:

Commencing at the NE Corner of Section 5, T56N-R33W, thence along the North line of said Section 5, S 89° 53' 54" W 138.76 feet to the Northerly boundary of Lakeshore Road; thence along the Northerly boundary of Lakeshore Road S 46° 03' 30" W 819.20 feet to the Point of Beginning; thence continuing Southwesterly along said line, a distance of 150.00 feet; thence N 43° 56' 30" W 201.95 feet to the shore of Lake Superior; thence along the shore of Lake Superior N 50° 10' 27" E 132.79 feet; thence along the shore of Lake Superior N 38° 42' 44" E 17.69 feet; thence S 43° 56' 30" E 194.68 feet to the Point of Beginning and containing 1.02 acres, more or less, including all land to the ordinary high water mark of Lake Superior and also being Parcel 27 of a Plat of Survey of Calumet Lakeshore.

SURVEYOR'S CERTIFICATE

TO: LAKE SUPERIOR LAND CO.

I, James M. Pardini, a Professional Land Surveyor in the State of Michigan, hereby certify that I have surveyed the parcel of land described and delineated hereon, that said plat is a true representation of the survey as performed by me, and that said survey was performed with an error of closure of 1 IN 24,711 and that I have fully complied with the requirements of Public Act 132 of 1970.

James M. Pardini
 James M. Pardini, P.L.S. No. 32340

			JAMES M. PARDINI Professional Land Surveyor Calumet, Michigan 49913		
			1/21/2005 DATE	J. PARDINI DRAWN BY	1" = 100' SCALE
SEC. 5, T56N-R33W			CALUMET TWP.		
FOR:					
SHEET 1 OF 1 SHEETS					

000740

Certified Boundary Survey

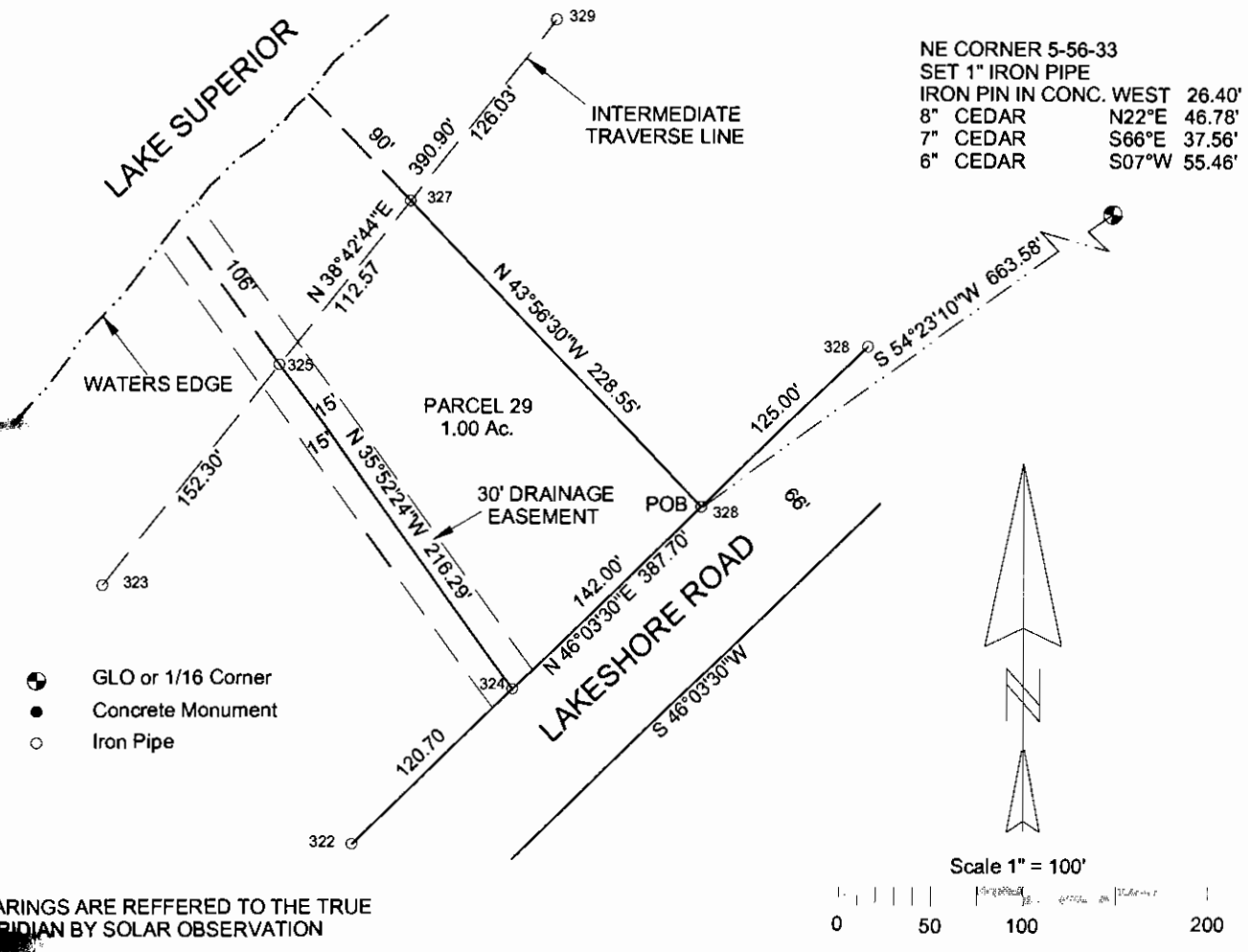

BEARINGS ARE REFERRED TO THE TRUE MERIDIAN BY SOLAR OBSERVATION

LEGAL DESCRIPTION PARCEL 29

A parcel of land in Government Lot 1 of Section 5, T56N-R33W, Calumet Township, Houghton County, Michigan and described as follows:

Commencing at the NE Corner of Section 5, T56N-R33W, thence along the North line of said Section 5, S 89° 53' 54" W 138.76 feet to the Northerly boundary of Lakeshore Road; thence along the Northerly boundary of Lakeshore Road S 46° 03' 30" W 556.50 feet to the Point of Beginning; thence continuing Southwesterly along said line, a distance of 142.00 feet; thence N 35° 52' 24" W 216.29 feet to the shore Lake Superior; thence along the shore of Lake Superior N 38° 42' 44" E 112.57 feet; thence S 43° 56' 30" E 228.55 feet to the Point of Beginning and containing 1.00 acres, more or less, including all land to the ordinary high water mark of Lake Superior and also being Parcel 29 of a Plat of Survey of Calumet Lakeshore.

Subject to a 30 foot wide drainage easement, the centerline of which is the existing stream channel along the Southwesterly side of said Parcel 29 as shown on a Plat of Survey of Calumet Lakeshore.

SURVEYOR'S CERTIFICATE

TO: LAKE SUPERIOR LAND CO.

I James M. Pardini, a Professional Land Surveyor in the State of Michigan, hereby certify that I have surveyed the parcel of land described and delineated hereon, that said plat is a true representation of the survey as performed by me, and that said survey was performed with an error of closure of 1 IN 24,711 and that I have fully complied with the requirements of Public Act 132 of 1970.

James M. Pardini
James M. Pardini, P.L.S. No. 32340

	JAMES M. PARDINI Professional Land Surveyor Calumet, Michigan 49913		
	1/24/2005 DATE	J. PARDINI DRAWN BY	1" = 100' SCALE
SEC. 5, T56N-R33W			CALUMET TWP.
FOR:			
SHEET 1 OF 1 SHEETS			

000741

Certified Boundary Survey

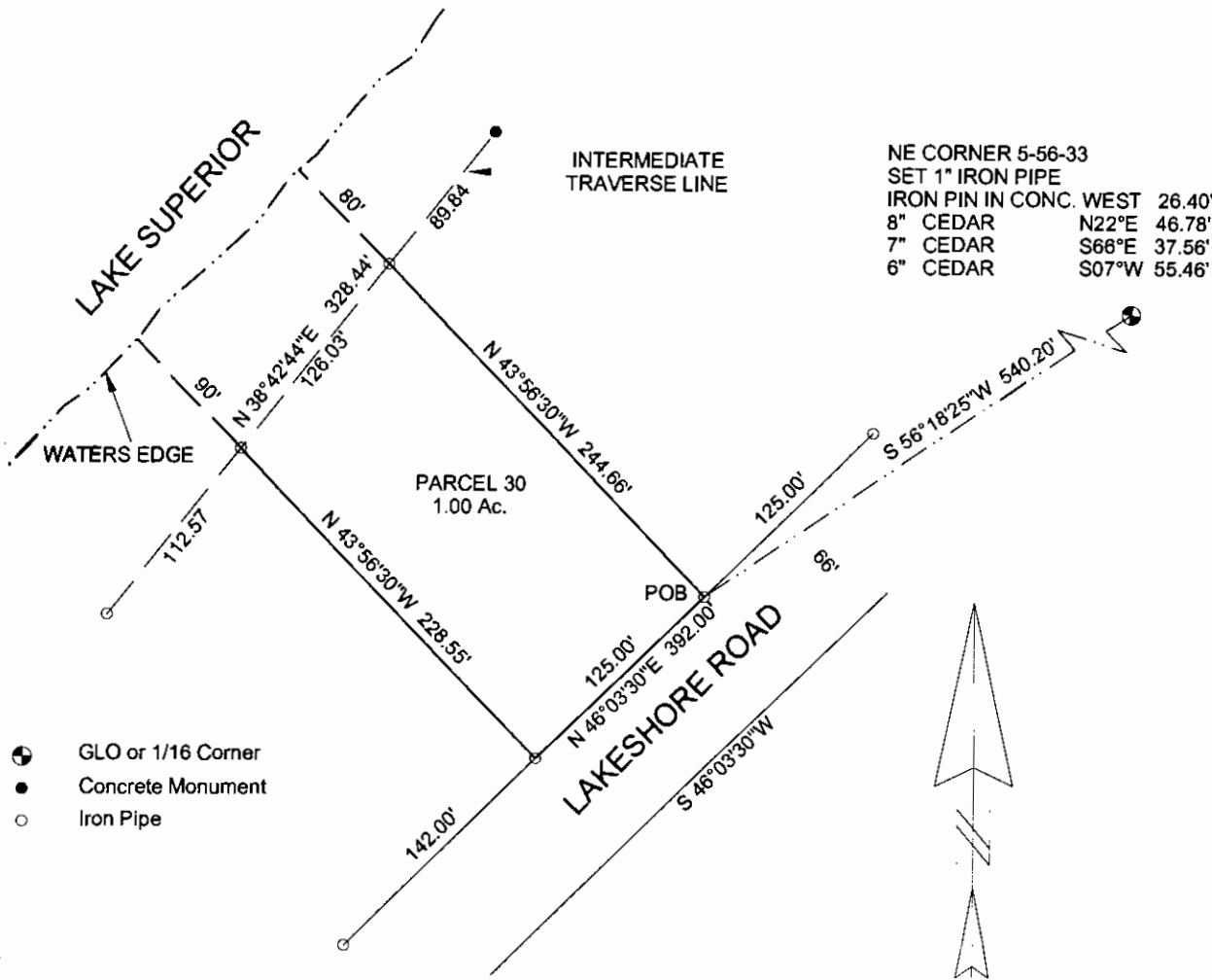

BEARINGS ARE REFERRED TO THE TRUE MERIDIAN BY SOLAR OBSERVATION

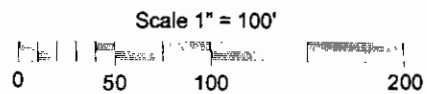

LEGAL DESCRIPTION PARCEL 30

A parcel of land in Government Lot 1 of Section 5, T56N-R33W, Calumet Township, Houghton County, Michigan and described as follows:

Commencing at the NE Corner of Section 5, T56N-R33W, thence along the North line of said Section 5, S 89° 53' 54" W 138.76 feet to the Northerly boundary of Lakeshore Road; thence along the Northerly boundary of Lakeshore Road S 46° 03' 30" W 431.50 feet to the Point of Beginning; thence continuing Southwesterly along said line, a distance of 125.00 feet; thence N 43° 56' 30" W 228.55 feet to the shore of Lake Superior; thence along the shore of Lake Superior N 38° 42' 44" E 126.03 feet; thence S 43° 56' 30" E 244.66 feet to the Point of Beginning and containing 1.00 acres, more or less, including all land to the ordinary high water mark of Lake Superior and also being Parcel 30 of a Plat of Survey of Calumet Lakeshore.

SURVEYOR'S CERTIFICATE

TO: LAKE SUPERIOR LAND CO.

I James M. Pardini, a Professional Land Surveyor in the State of Michigan, hereby certify that I have surveyed the parcel of land described and delineated hereon, that said plat is a true representation of the survey as performed by me, and that said survey was performed with an error of closure of 1 IN 24,711 and that I have fully complied with the requirements of Public Act 132 of 1970.

James M. Pardini
 James M. Pardini, P.L.S. No. 32340

	JAMES M. PARDINI Professional Land Surveyor Calumet, Michigan 49913		
	1/24/2005 DATE	J. PARDINI DRAWN BY	1" = 100' SCALE
SEC. 5, T56N-R33W CALUMET TWP.			
FOR:			
SHEET 1 OF 1 SHEETS			

000742

Mary Schoos
Register of Deeds
PAU Date 02/14/2005 Time 11:11:24
FEE: 14.00
Page 1 of 1
SM 3/742

Certified Boundary Survey

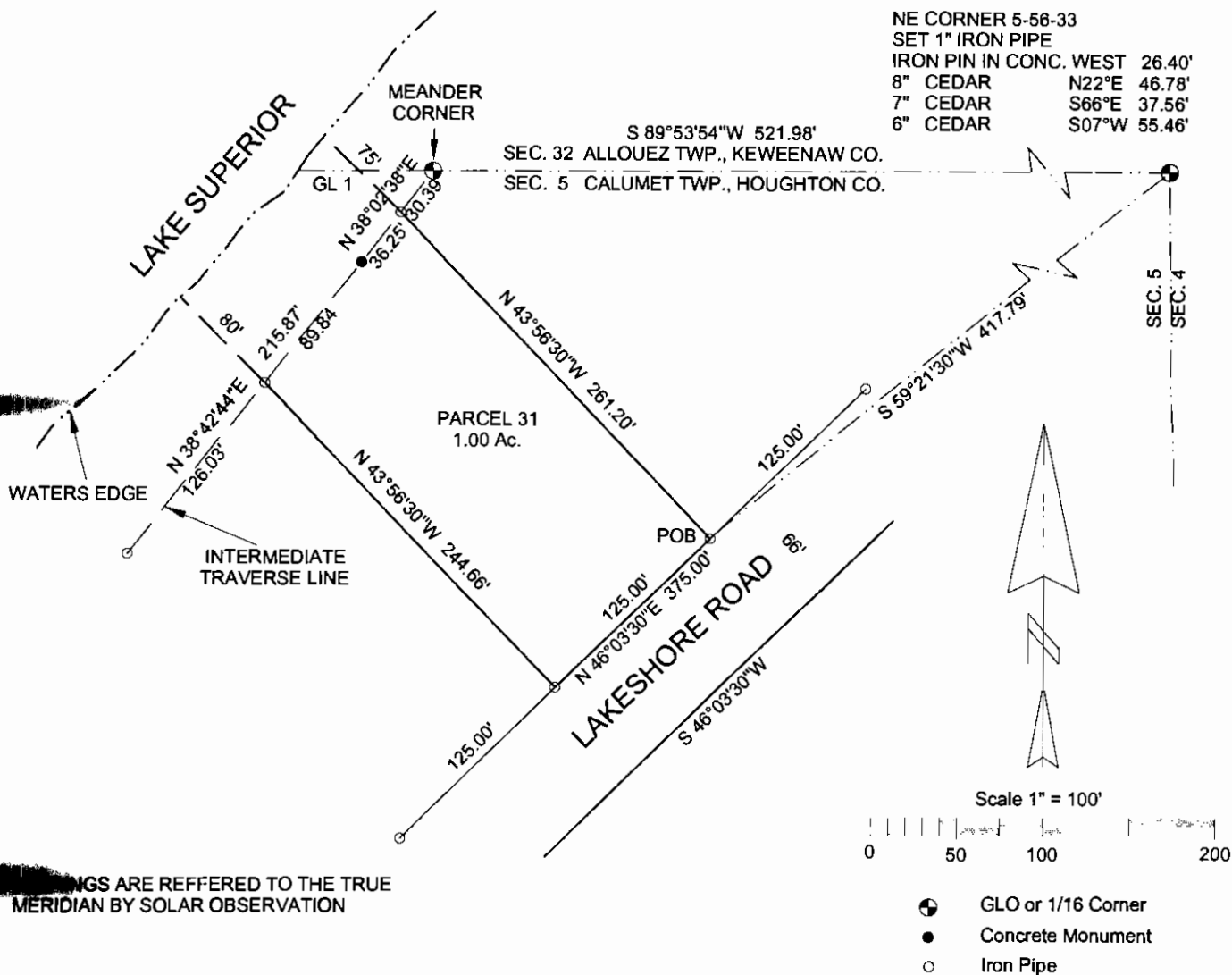

ALL BEARINGS ARE REFERRED TO THE TRUE MERIDIAN BY SOLAR OBSERVATION

LEGAL DESCRIPTION PARCEL 31

A parcel of land in Government Lot 1 of Section 5, T56N-R33W, Calumet Township, Houghton County and Fractional Section 32, T57N-R33W, Allouez Township, Keweenaw County, Michigan and described as follows:

Commencing at the NE Corner of Section 5, T56N-R33W, thence along the North line of said Section 5, S 89° 53' 54" W 138.76 feet to the Northerly boundary of Lakeshore Road; thence along the Northerly boundary of Lakeshore Road S 46° 03' 30" W 306.50 feet to the Point of Beginning; thence continuing Southwesterly along said line, a distance of 125.00 feet; thence N 43° 56' 30" W 244.66 feet to the shore of Lake Superior; thence along the shore of Lake Superior N 38° 42' 44" E 89.84 feet; thence along the shore of Lake Superior N 38° 02' 38" E 36.25 feet; thence S 43° 56' 30" E 261.20 feet to the Point of Beginning and containing 1.00 acres, more or less, including all land to the ordinary high water mark of Lake Superior and also being Parcel 31 of a Plat of Survey of Calumet Lakeshore.

SURVEYOR'S CERTIFICATE

TO: LAKE SUPERIOR LAND CO.

I, James M. Pardini, a Professional Land Surveyor in the State of Michigan, hereby certify that I have surveyed the parcel of land described and delineated hereon, that said plat is a true representation of the survey as performed by me, and that said survey was performed with an error of closure of 1 IN 24,711 and that I have fully complied with the requirements of Public Act 132 of 1970.

James M. Pardini
James M. Pardini, P.L.S. No. 32340

			JAMES M. PARDINI Professional Land Surveyor Calumet, Michigan 49913		
			1/25/2005 DATE	J. PARDINI DRAWN BY	1" = 100' SCALE
SEC. 5, T56N-R33W SEC. 32, T57N-R33W			CALUMET TWP. ALLOUEZ TWP.		
FOR:					
SHEET 1 OF 1 SHEETS					

000743

Certified Boundary Survey

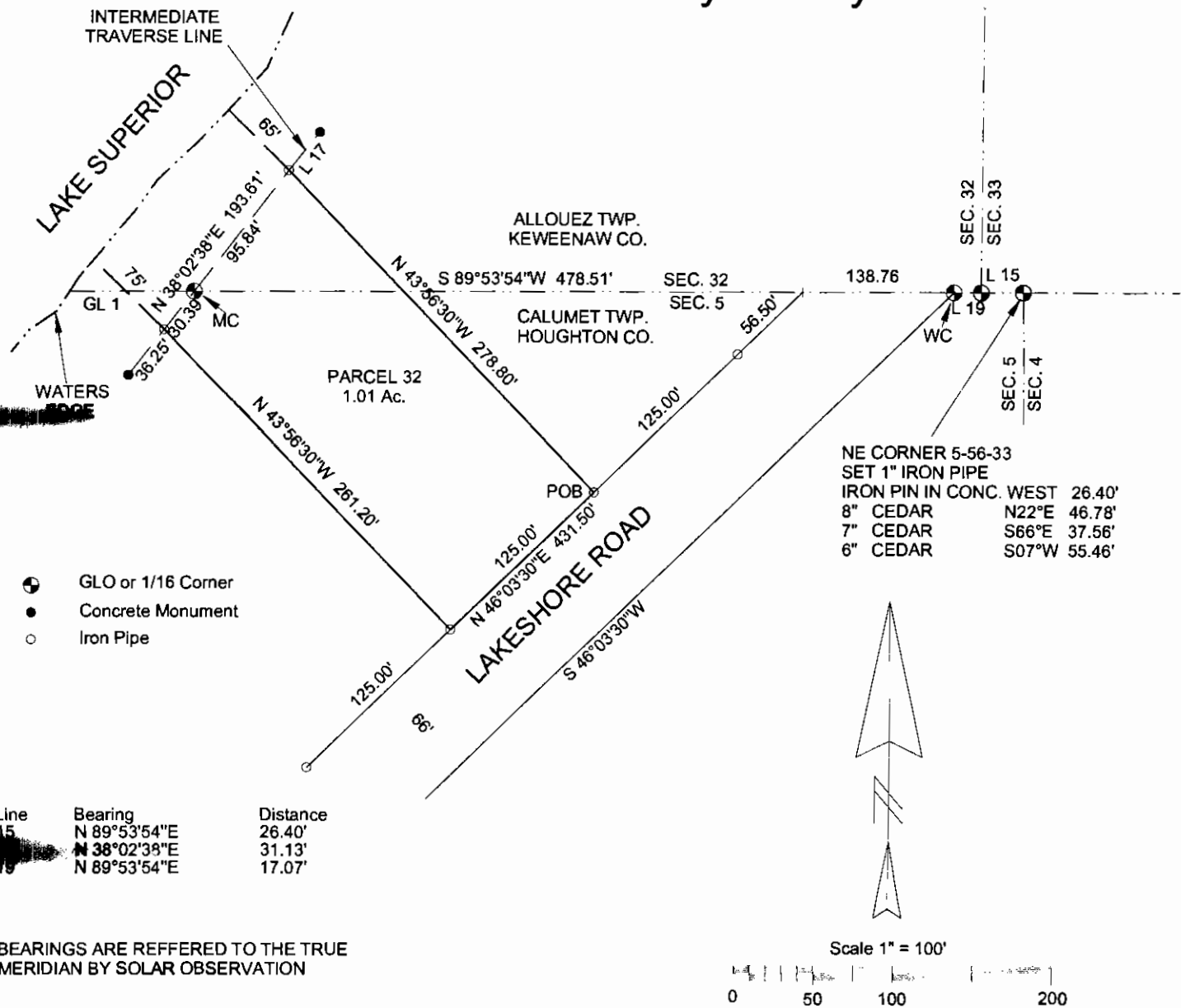

LEGAL DESCRIPTION PARCEL 32

A parcel of land in Government Lot 1 of Section 5, T56N-R33W, Calumet Township, Houghton County and Fractional Section 32, T57N-R33W, Allouez Township, Keweenaw County, Michigan and described as follows:

Commencing at the NE Corner of Section 5, T56N-R33W, thence along the North line of Section 5, S 89° 53' 54" W 138.76 feet to the Northerly boundary of Lakeshore Road; thence along the Northerly boundary of Lakeshore Road S 46° 03' 30" W 181.50 feet to the Point of Beginning; thence continuing Southwesterly along said line, a distance of 125.00 feet; thence N 43° 56' 30" W 261.20 feet to the shore of Lake Superior; thence along the shore of Lake Superior N 38° 02' 38" E 126.23 feet; thence S 43° 56' 30" E 278.80 feet to the Point of Beginning and containing 1.01 acres, more or less, including all land to the ordinary high water mark of Lake Superior and also being Parcel 32 of a Plat of Survey of Calumet Lakeshore.

SURVEYOR'S CERTIFICATE

TO: LAKE SUPERIOR LAND CO.

I James M. Pardini, a Professional Land Surveyor in the State of Michigan, hereby certify that I have surveyed the parcel of land described and delineated hereon, that said plat is a true representation of the survey as performed by me, and that said survey was performed with an error of closure of 1 IN 24,711 and that I have fully complied with the requirements of Public Act 132 of 1970.

James M. Pardini
 James M. Pardini, P.L.S. No. 32340



JAMES M. PARDINI Professional Land Surveyor Calumet, Michigan 49913		
1/25/2005 DATE	J. PARDINI DRAWN BY	1" = 100' SCALE
SEC. 5, T56N-R33W SEC. 32, T57N-R33W		CALUMET TWP. ALLOUEZ TWP.
FOR:		
SHEET 1 OF 1 SHEETS		

000714

Certified Boundary Survey

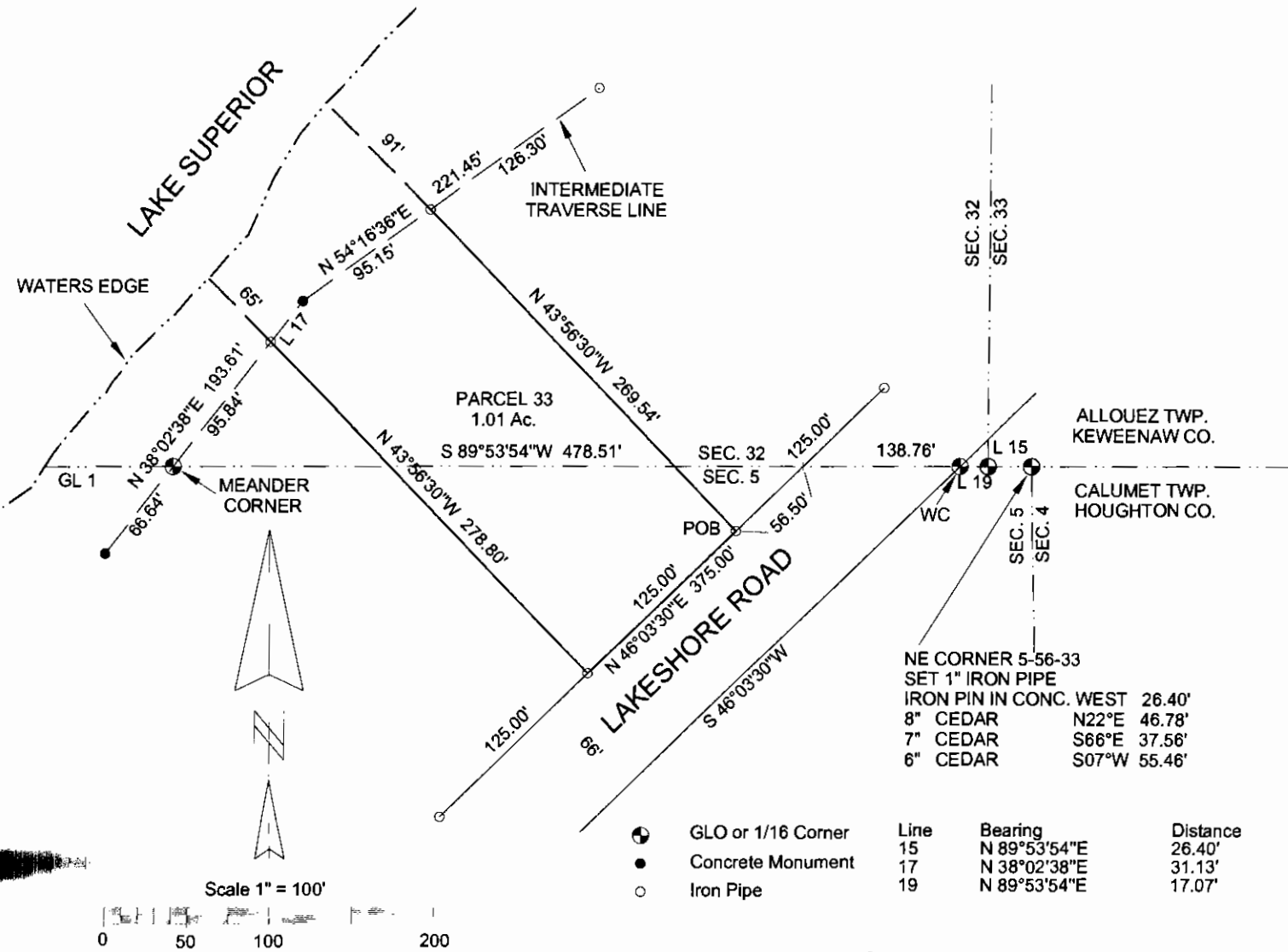

BEARINGS ARE REFERRED TO THE TRUE MERIDIAN BY SOLAR OBSERVATION

LEGAL DESCRIPTION PARCEL 33

A parcel of land in Government Lot 1 of Section 5, T56N-R33W, Calumet Township, Houghton County and Fractional Section 32, T57N-R33W, Allouez Township, Keweenaw County, Michigan and described as follows:

Commencing at the NE Corner of Section 5, T56N-R33W, thence along the North line of said Section 5, S 89° 53' 54" W 138.76 feet to the Northerly boundary of Lakeshore Road; thence along the Northerly boundary of Lakeshore Road S 46° 03' 30" W 56.50 feet to the Point of Beginning; thence continuing Southwesterly along said line, a distance of 125.00 feet; thence N 43° 56' 30" W 278.80 feet to the shore of Lake Superior; thence along the shore of Lake Superior N 38° 02' 38" E 31.13 feet; thence along the shore of Lake Superior N 54° 16' 36" E 95.15 feet; thence S 43° 56' 30" E 269.54 feet to the Point of Beginning and containing 1.01 acres, more or less, including all land to the ordinary high water mark of Lake Superior and also being Parcel 33 of a Plat of Survey of Calumet Lakeshore.

SURVEYOR'S CERTIFICATE

TO: LAKE SUPERIOR LAND CO.

I James M. Pardini, a Professional Land Surveyor in the State of Michigan, hereby certify that I have surveyed the parcel of land described and delineated hereon, that said plat is a true representation of the survey as performed by me, and that said survey was performed with an error of closure of 1 IN 24,711 and that I have fully complied with the requirements of Public Act 132 of 1970.

James M. Pardini
James M. Pardini, P.L.S. No. 32340



JAMES M. PARDINI Professional Land Surveyor Calumet, Michigan 49913		
1/26/2005 DATE	J. PARDINI DRAWN BY	1" = 100' SCALE
SEC. 5, T56N-R33W SEC. 32, T57N-R33W		CALUMET TWP. ALLOUEZ TWP.
FOR:		
SHEET 1 OF 1 SHEETS		

REGISTRAR'S OFFICE

County of Keweenaw

SS

Received for Record, the

15th

day of February

A.D. 2005

at 10:40 o'clock A.M.

and Recorded

in Lib. 2

of Surveys

CB 158-205

Certified Boundary Survey

Julie A. Carlson, Deputy

Register of Deeds

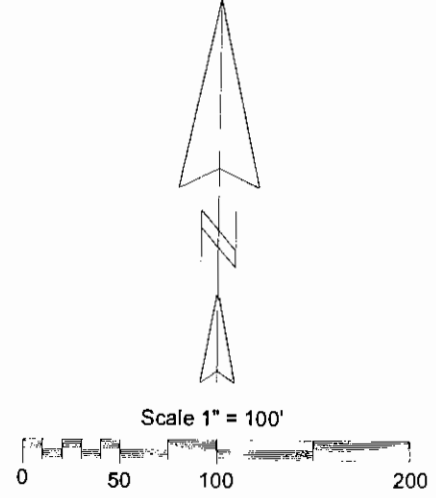
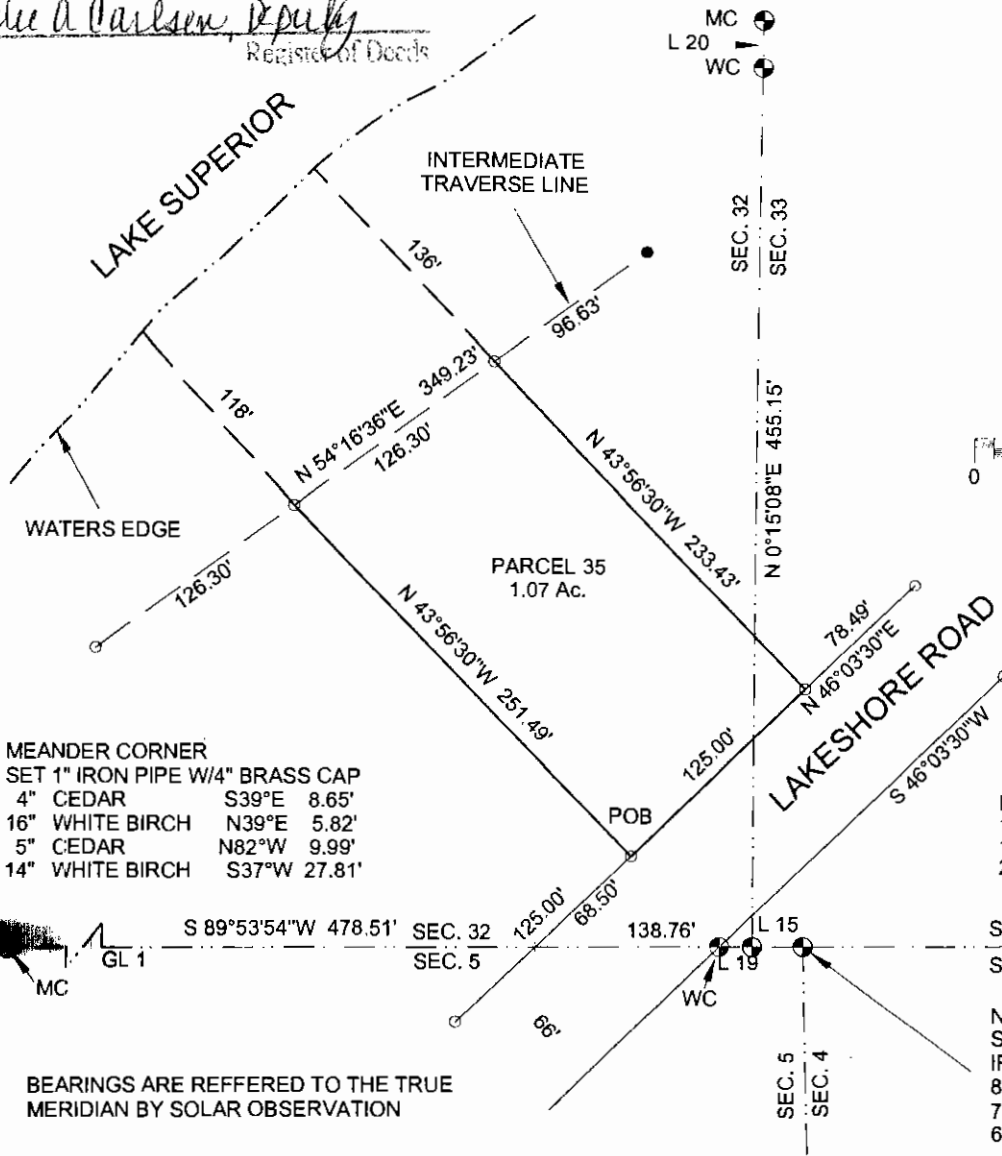

- GLO or 1/16 Corner
- Concrete Monument
- Iron Pipe
- ▲ Traverse Point

Line	Bearing	Distance
15	N 89°53'54"E	26.40'
19	N 89°53'54"E	17.07'
20	N 00°15'08"W	24.67'

SEC. 33 ALLOUEZ TWP., KEWEENAW CO.
 SEC. 4 CALUMET TWP., HOUGHTON CO.

NE CORNER 5-56-33
 SET 1" IRON PIPE
 IRON PIN IN CONC. WEST 26.40'
 8" CEDAR N22°E 46.78'
 7" CEDAR S66°E 37.56'
 6" CEDAR S07°W 55.46'

LEGAL DESCRIPTION PARCEL 35

A parcel of land in Fractional Section 32 and Government Lot 4 of Section 33, T57N-R33W, Allouez Township, Keweenaw County, Michigan and described as follows:

Commencing at the NE Corner of Section 5, T56N-R33W, thence along the North line of said Section 5, S 89° 53' 54" W 138.76 feet to the Northerly boundary of Lakeshore Road; thence along the Northerly boundary of Lakeshore Road N 46° 03' 30" E 68.50 feet to the Point of Beginning; thence N 43° 56' 30" W 251.49 feet to the shore of Lake Superior; thence along the shore of Lake Superior N 54° 16' 36" E 126.30 feet; thence S 43° 56' 30" E 233.43 feet to the Northerly boundary of Lakeshore Road; thence along the Northerly boundary of Lake Shore Road S 46° 03' 30" W 125.00 feet to the Point of Beginning and containing 1.07 acres, more or less, including all land to the ordinary high water mark of Lake Superior and also being Parcel 35 of a Plat of Survey of Calumet Lakeshore.

SURVEYOR'S CERTIFICATE

TO: LAKE SUPERIOR LAND CO.

I, James M. Pardini, a Professional Land Surveyor in the State of Michigan, hereby certify that I have surveyed the parcel of land described and delineated hereon, that said plat is a true representation of the survey as performed by me, and that said survey was performed with an error of closure of 1 IN 24,711 and that I have fully complied with the requirements of Public Act 132 of 1970.

James M. Pardini
 James M. Pardini, P.L.S. No. 32340

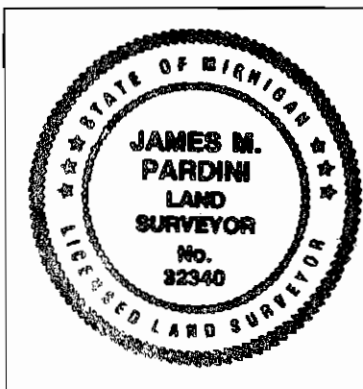

JAMES M. PARDINI Professional Land Surveyor Calumet, Michigan 49913		
1/26/2005 DATE	J. PARDINI DRAWN BY	1" = 100' SCALE
SEC. 32 and 33, T57N-R33W		ALLOUEZ TWP.
FOR:		
SHEET 1 OF 1 SHEETS		

Certified Boundary Survey

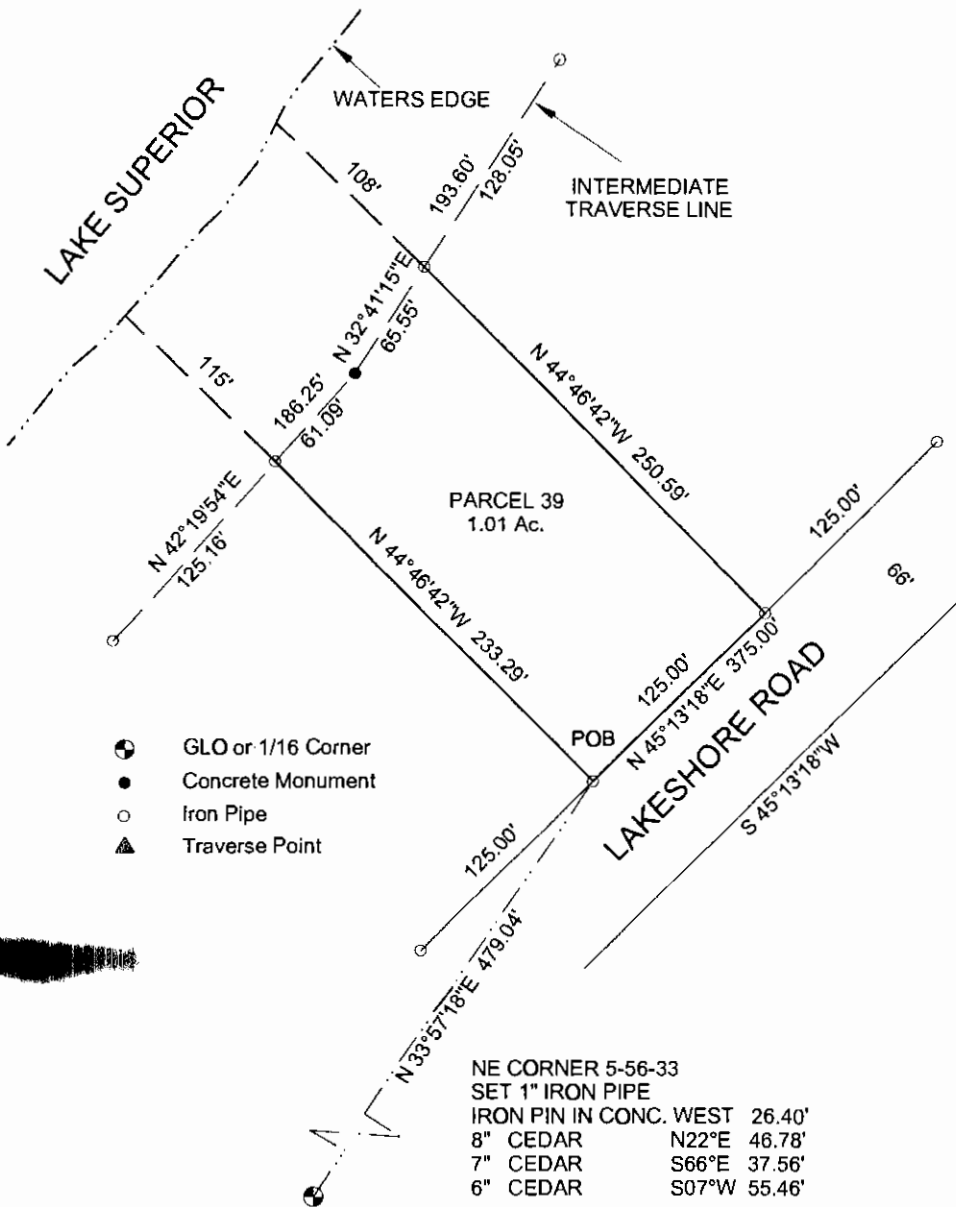

REGISTER'S OFFICE }
 County of Keweenaw } SS
 Received for Record, the 15th
 day of February A.D. 2005
 at 10:40 o'clock A. M., and Recorded
 in Liber 2 of Surveys
 on page 209
Janie Carlson, Deputy
 Register of Deeds

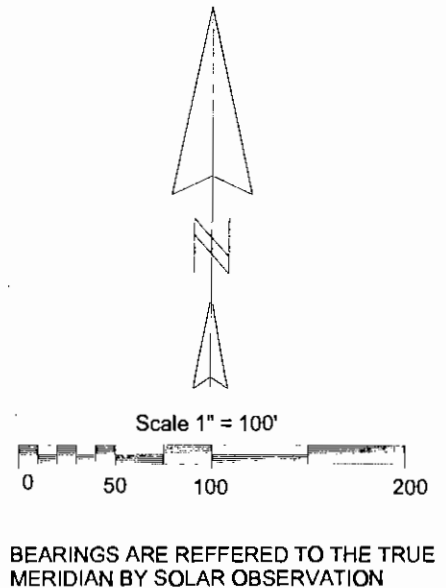

LEGAL DESCRIPTION PARCEL 39

A parcel of land in Government Lot 4 of Section 33, T57N-R33W, Allouez Township, Keweenaw County, Michigan and described as follows:

Commencing at the NE Corner of Section 5, T56N-R33W, thence along the North line of said Section 5, S 89° 53' 54" W 138.76 feet to the Northerly boundary of Lakeshore Road; thence along the Northerly boundary of Lakeshore Road the following two courses; N 46° 03' 30" E 272.00 feet; thence N 45° 13' 18" E 296.51 feet to the Point of Beginning; thence N 44° 46' 42" W 233.29 feet to the shore of Lake Superior; thence along the shore of Lake Superior the following two courses; N 42° 19' 54" E 61.09 feet; thence N 32° 41' 15" E 65.55 feet; thence S 44° 46' 42" E 250.59 feet to the Northerly boundary of Lakeshore Road; thence along the Northerly boundary of Lakeshore Road S 45° 13' 18" W 125.00 feet to the Point of Beginning and containing 1.01 acres, more or less, including all land to the ordinary high water mark of Lake Superior and also being Parcel 39 of a Plat of Survey of Calumet Lakeshore.

SURVEYOR'S CERTIFICATE

TO: LAKE SUPERIOR LAND CO.

I James M. Pardini, a Professional Land Surveyor in the State of Michigan, hereby certify that I have surveyed the parcel of land described and delineated hereon, that said plat is a true representation of the survey as performed by me, and that said survey was performed with an error of closure of 1 IN 24,711 and that I have fully complied with the requirements of Public Act 132 of 1970.

James M. Pardini
 James M. Pardini, P.L.S. No. 32340

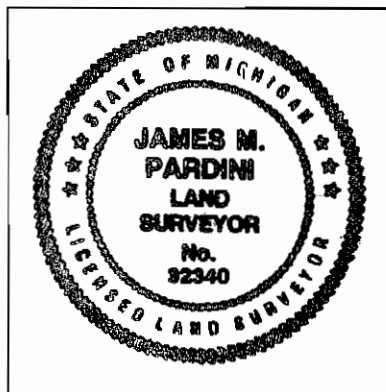

JAMES M. PARDINI Professional Land Surveyor Calumet, Michigan 49913		
1/27/2005	J. PARDINI	1" = 100'
DATE	DRAWN BY	SCALE
SEC. 33, T57N-R33W		ALLOUEZ TWP.
FOR:		
SHEET 1 OF 1 SHEETS		

Certified Boundary Survey

REGISTRY'S OFFICE } SS
 County of Calumet }
 Received for record on 15th
 of February A.D. 20 05
 at 10:40 AM
 in Case No. 2
 of Surveys
 216
Paula Carlson, Deputy
 Register

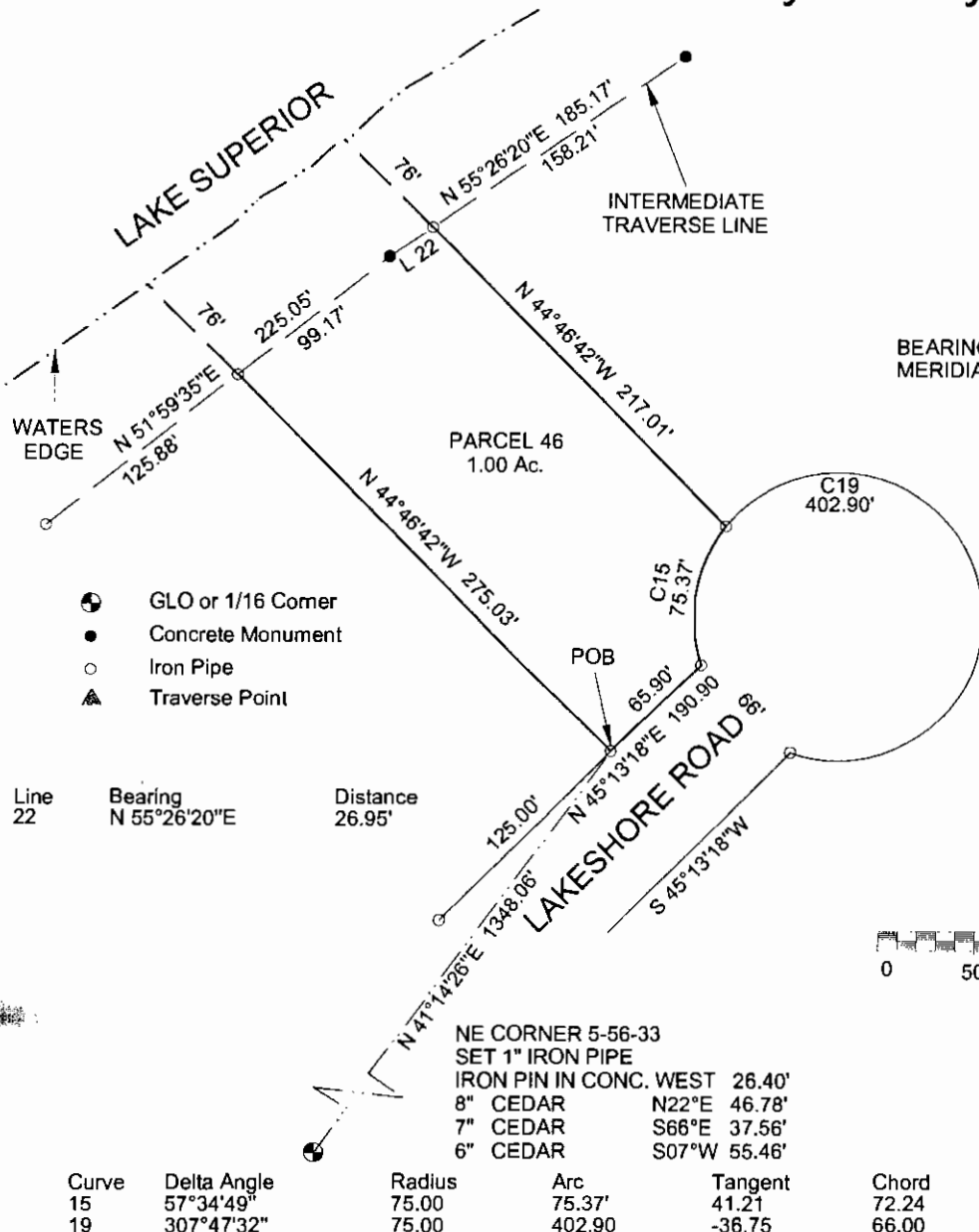

BEARINGS ARE REFERRED TO THE TRUE MERIDIAN BY SOLAR OBSERVATION

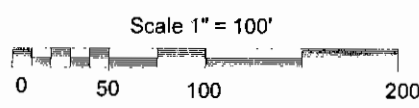
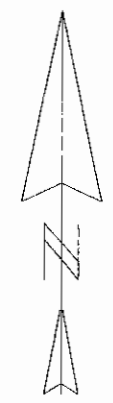

LEGAL DESCRIPTION PARCEL 46

A parcel of land in Government Lot 4 of Section 33, T57N-R33W, Allouez Township, Keweenaw County, Michigan and described as follows:

Commencing at the NE Corner of Section 5, T56N-R33W, thence along the North line of said Section 5, S 89° 53' 54" W 138.76 feet to the Northerly boundary of Lakeshore Road; thence along the Northerly boundary of Lakeshore Road the following two courses; N 46° 03' 30" E 272.00 feet; thence N 45° 13' 18" E 1171.51 feet to the Point of Beginning; thence N 44° 46' 42" W 275.03 feet to the shore of Lake Superior; thence along the shore of Lake Superior the following two courses; N 51° 59' 36" E 99.17 feet; thence N 55° 26' 20" E 26.95 feet; thence S 44° 46' 42" E 217.01 feet to the Northerly boundary of Lakeshore Road and a point of curve, concave to the to the left, having a radius of 75.00 feet, a central angle of 57° 34' 49", and a chord of 72.24 feet bearing S 10° 06' 50" W; thence along the Northerly boundary of Lakeshore Road and Southerly along said curve, a distance of 75.37 feet; thence along the Northerly boundary of Lakeshore Road S 45° 13' 18" W 65.90 feet to the Point of Beginning and containing 1.00 acres, more or less, including all land to the ordinary high water mark of Lake Superior and also being Parcel 46 of a Plat of Survey of Calumet Lakeshore.

SURVEYOR'S CERTIFICATE

TO: LAKE SUPERIOR LAND CO.

I James M. Pardini, a Professional Land Surveyor in the State of Michigan, hereby certify that I have surveyed the parcel of land described and delineated hereon, that said plat is a true representation of the survey as performed by me, and that said survey was performed with an error of closure of 1 IN 24,711 and that I have fully complied with the requirements of Public Act 132 of 1970.

James M. Pardini
 James M. Pardini, P.L.S. No. 32340

	JAMES M. PARDINI Professional Land Surveyor Calumet, Michigan 49913	
	2/1/2005 DATE	J. PARDINI DRAWN BY
SEC. 33, T57N-R33W		ALLOUEZ TWP.
FOR:		
SHEET 1 OF 1 SHEETS		

REGISTER'S OFFICE }
 County of Keweenaw }
 discovered for Record, the }
 15th }
 day of February A.D. 2005 }
 at 10:40 AM by }
 in Liber 2 of }
 on page 217 }
Julia Carlson Deputy
 REGISTER OF DEEDS

Certified Boundary Survey

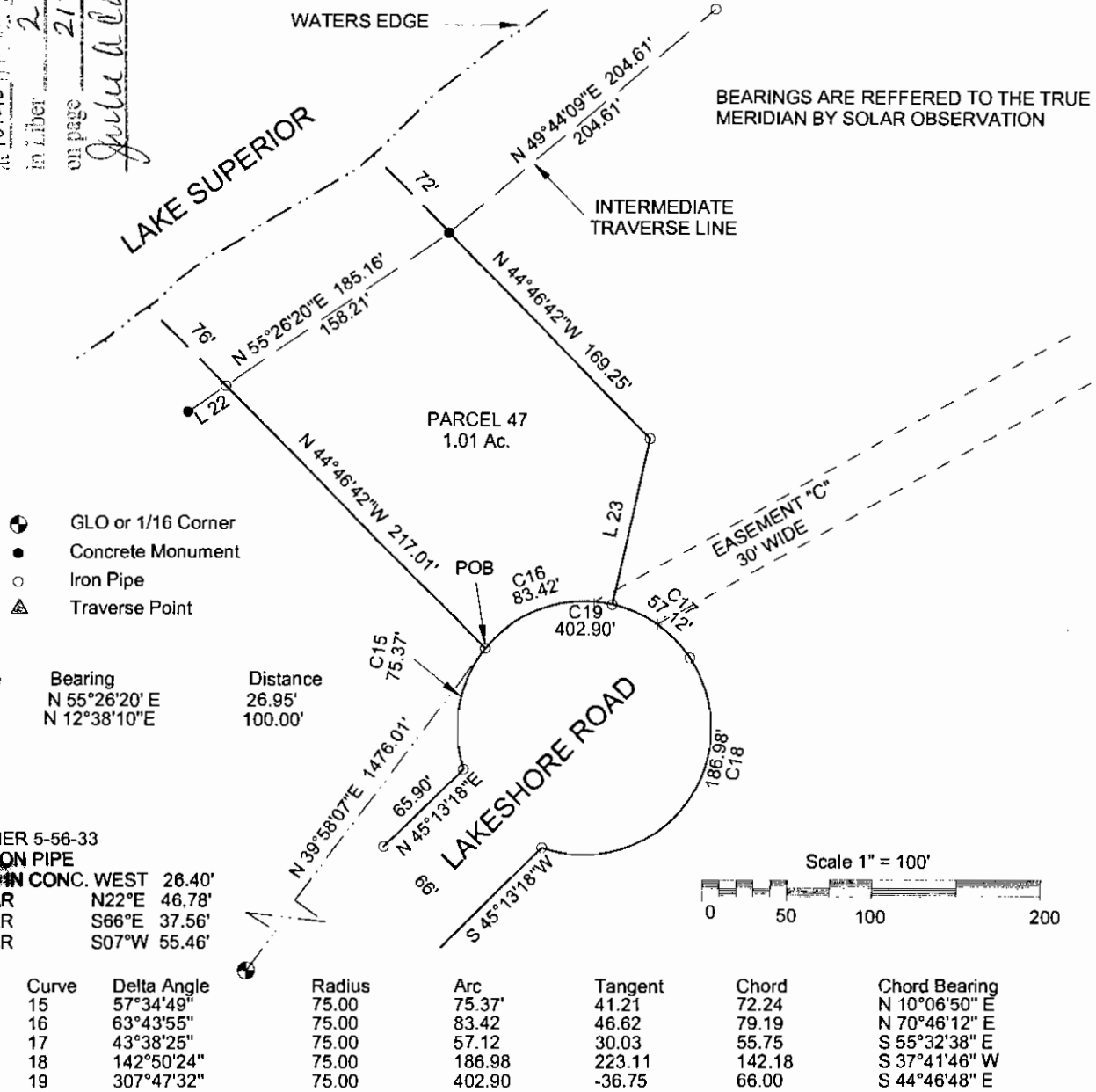

BEARINGS ARE REFERRED TO THE TRUE MERIDIAN BY SOLAR OBSERVATION

- ⊙ GLO or 1/16 Corner
- Concrete Monument
- Iron Pipe
- ▲ Traverse Point

Line	Bearing	Distance
22	N 55°26'20" E	26.95'
23	N 12°38'10" E	100.00'

NE CORNER 5-56-33
 SET IRON PIPE
 IN CONC. WEST 26.40'
 8" CEDAR N22°E 46.78'
 7" CEDAR S66°E 37.56'
 6" CEDAR S07°W 55.46'

Curve	Delta Angle	Radius	Arc	Tangent	Chord	Chord Bearing
15	57°34'49"	75.00	75.37'	41.21	72.24	N 10°06'50" E
16	63°43'55"	75.00	83.42	46.62	79.19	N 70°46'12" E
17	43°38'25"	75.00	57.12	30.03	55.75	S 55°32'38" E
18	142°50'24"	75.00	186.98	223.11	142.18	S 37°41'46" W
19	307°47'32"	75.00	402.90	-36.75	66.00	S 44°46'48" E

LEGAL DESCRIPTION PARCEL 47

A parcel of land in Government Lot 4 of Section 33, T57N-R33W, Allouez Township, Keweenaw County, Michigan and described as follows:

Commencing at the NE Corner of Section 5, T56N-R33W, thence along the North line of said Section 5, S 89° 53' 54" W 138.76 feet to the Northerly boundary of Lakeshore Road; thence along the Northerly boundary of Lakeshore Road the following three courses; N 46° 03' 30" E 272.00 feet; thence N 45° 13' 18" E 1237.41 feet to a point of curve, concave to the to the right, having a radius of 75.00 feet, a central angle of 57° 34' 49", and a chord of 72.24 feet bearing N 10° 06' 50" E; thence Northerly along said curve, a distance of 75.37 feet to the point being the Point of Beginning; thence N 44° 46' 42" W 217.01 feet to the shore of Lake Superior; thence along the shore of Lake Superior N 55° 26' 20" E 158.21 feet; thence S 44° 46' 42" E 169.25 feet; thence S 12° 38' 10" W 100.00 feet to the Northerly boundary of Lakeshore Road and a point of curve, concave to the to the left, having a radius of 75.00 feet, a central angle of 63° 43' 55", and a chord of 79.19 feet bearing S 70° 46' 12" W; thence along the Northerly boundary of Lakeshore Road and Westerly along said curve, a distance of 83.42 feet to the Point of Beginning and containing 1.01 acres, more or less, including all land to the ordinary high water mark of Lake Superior and also being Parcel 47 of a Plat of Survey of Calumet Lakeshore.

Subject to a 30 foot wide waterline easement as shown on a Plat of Survey of Calumet Lakeshore.

SURVEYOR'S CERTIFICATE

TO: LAKE SUPERIOR LAND CO.

I James M. Pardini, a Professional Land Surveyor in the State of Michigan, hereby certify that I have surveyed the parcel of land described and delineated hereon, that said plat is a true representation of the survey as performed by me, and that said survey was performed with an error of closure of 1 IN 24,711 and that I have fully complied with the requirements of Public Act 132 of 1970.

James M. Pardini
 James M. Pardini, P.L.S. No. 32340

	JAMES M. PARDINI Professional Land Surveyor Calumet, Michigan 49913	
	2/1/2005 DATE	J. PARDINI DRAWN BY
SEC. 33, T57N-R33W		ALLOUEZ TWP.
FOR:		
SHEET 1 OF 1 SHEETS		

REGISTER'S OFFICE }
 County of Keweenaw } SS
 Received for Record, the 15th
 day of February A.D. 20 05
 at 10:40 o'clock A.M. and Recorded
 in Liber 2 of Surveys
 on page 218

Certified Boundary Survey

James M. Pardini, Deputy
 Registrar of Deeds

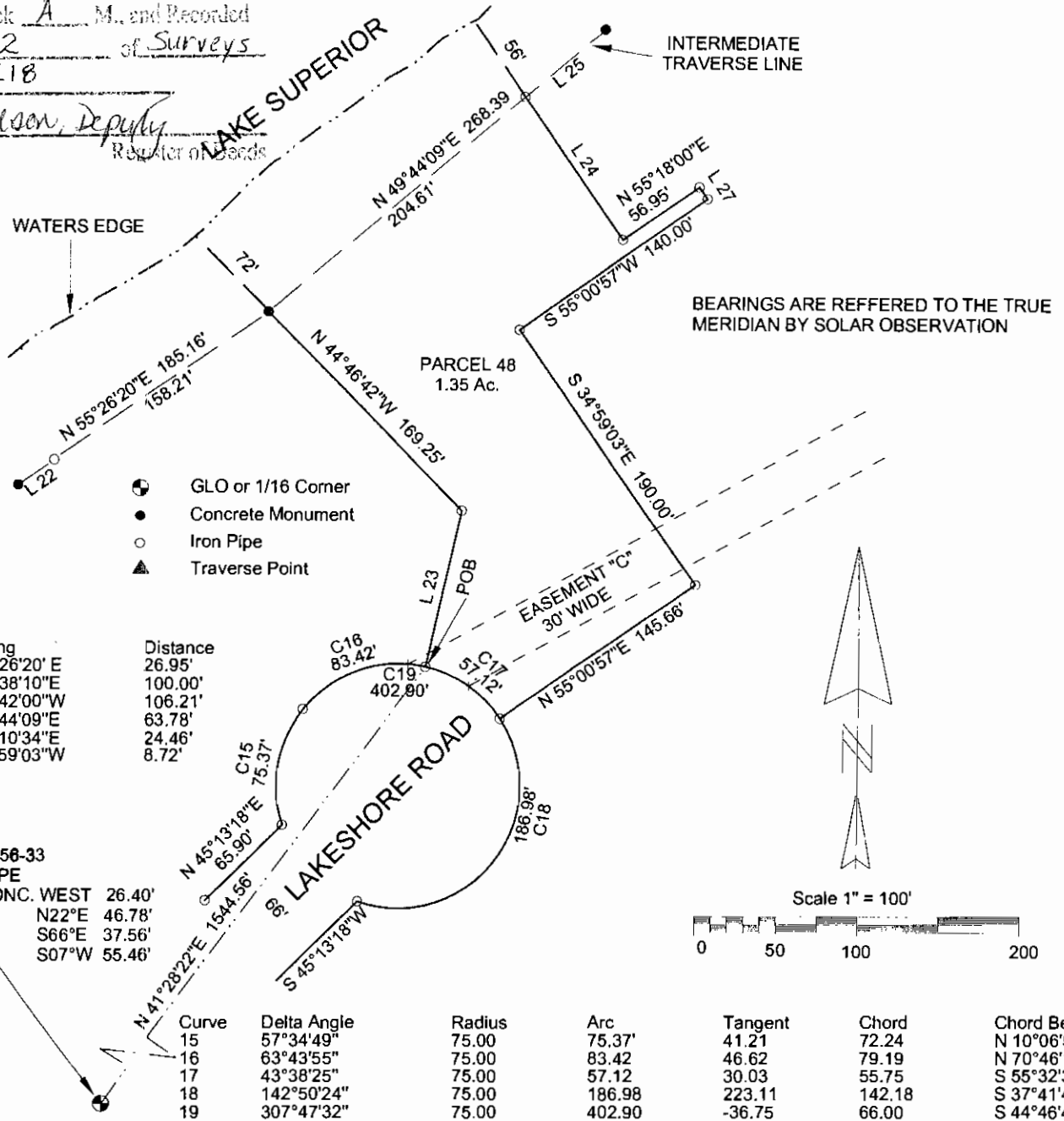

Line	Bearing	Distance
22	N 55°26'20" E	26.95'
23	N 12°38'10" E	100.00'
24	N 34°42'00" W	106.21'
25	N 49°44'09" E	63.78'
26	N 00°10'34" E	24.46'
27	N 34°59'03" W	8.72'

SET 1" IRON PIPE
 IRON PIN IN CONC. WEST 26.40'
 8" CEDAR N22°E 46.78'
 7" CEDAR S66°E 37.56'
 6" CEDAR S07°W 55.46'

Curve	Delta Angle	Radius	Arc	Tangent	Chord	Chord Bearing
15	57°34'49"	75.00	75.37'	41.21	72.24	N 10°06'50" E
16	63°43'55"	75.00	83.42	46.62	79.19	N 70°46'12" E
17	43°38'25"	75.00	57.12	30.03	55.75	S 55°32'38" E
18	142°50'24"	75.00	186.98	223.11	142.18	S 37°41'46" W
19	307°47'32"	75.00	402.90	-36.75	66.00	S 44°46'48" E

LEGAL DESCRIPTION PARCEL 48

A parcel of land in Government Lot 4 of Section 33, T57N-R33W, Allouez Township, Keweenaw County, Michigan and described as follows:

Commencing at the NE Corner of Section 5, T56N-R33W, thence along the North line of said Section 5, S 89° 53' 54" W 138.76 feet to the Northerly boundary of Lakeshore Road; thence along the Northerly boundary of Lakeshore Road the following three courses; N 46° 03' 30" E 272.00 feet; thence N 45° 13' 18" E 1237.41 feet to a point of curve, concave to the to the right, having a radius of 75.00 feet, a central angle of 121° 18' 44", and a chord of 130.75 feet bearing N 41° 58' 47" E; thence Northeasterly along said curve, a distance of 158.80 feet to the Point of Beginning; thence N 12° 38' 10" E 100.00 feet; thence N 44° 46' 42" W 169.25 feet to the shore of Lake Superior; thence along the shore of Lake Superior N 49° 44' 09" E 204.61 feet; thence S 34° 42' 00" E 106.21 feet; thence N 55° 18' 00" E 56.95 feet; thence S 34° 59' 03" E 8.72 feet; thence S 55° 00' 57" W 140.00 feet; thence S 34° 59' 03" E 190.00 feet; thence S 55° 00' 57" W 145.66 feet to the boundary of Lakeshore Road and a point of curve, concave to the to the left, having a radius of 75.00 feet, a central angle of 43° 38' 25", and a chord of 55.75 feet bearing N 55° 32' 38" W; thence Northwesterly along said curve, a distance of 57.12 feet to the Point of Beginning and containing 1.35 acres, more or less, including all land to the ordinary high water mark of Lake Superior and also being Parcel 48 of a Plat of Survey of Calumet Lakeshore.

Subject to a 30 foot wide waterline easement as shown on a Plat of Survey of Calumet Lakeshore.

SURVEYOR'S CERTIFICATE

TO: LAKE SUPERIOR LAND CO.

I James M. Pardini, a Professional Land Surveyor in the State of Michigan, hereby certify that I have surveyed the parcel of land described and delineated hereon, that said plat is a true representation of the survey as performed by me, and that said survey was performed with an error of closure of 1 IN 24,711 and that I have fully complied with the requirements of Public Act 132 of 1970.

James M. Pardini
 James M. Pardini, P.L.S. No. 32340

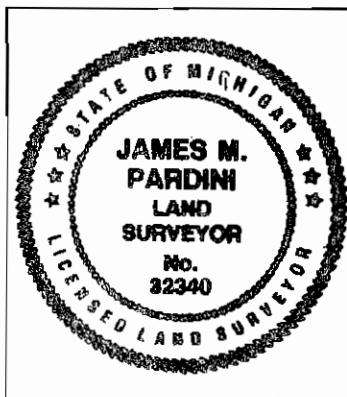

JAMES M. PARDINI Professional Land Surveyor Calumet, Michigan 49913		
2/1/2005 DATE	J. PARDINI DRAWN BY	1" = 100' SCALE
SEC. 33, T 57N-R33W		ALLOUEZ TWP.
FOR:		
SHEET 1 OF 1 SHEETS		